

**A  
USERS GUIDE  
TO  
AIRCRAFT RADIO  
CORPORATION  
RECEIVERS**

**by  
M. W. Tauson**

One of the neat things about the military is the rather vast quantities in which it produces surplus for people like us to pick up in equally vast quantities. This process has most likely been going on since Ceasar's time (although I suspect the market has probably changed a bit) and will continue as long as there are militaries to have surplus.

Probably the one group of radio equipment to hit the market more heavily than any other is that known as the Command sets. These units (specifically the ATA/ARA, SCR-274N, and ARC-5 sets) were released as surplus after World War II and are still showing up in new, unused condition some 35 years later. They have been converted from mild to wild and are responsible for getting quite a few people on the air who could not have otherwise afforded a rig...myself included.

The original design that started this avalanche came from Aircraft Radio Corporation. There were three major builders, A.P.C., Stromberg-Carlson who built most of the early ATA/ARA sets as well as some of the ARC-5's and later Type 12's, and Western Electric who built most of the SCR-274N's (Navy rigs with Army markings essentially) plus the VHF Command sets. There were other suppliers but not any that produced the quantities that these did.

As a general rule, SCR-274N and ATA/ARA equipment may be mixed freely. ARC-5 receivers may be used with the other two series, as may the racks, control boxes, etc. ARC-5 transmitters, modulators, racks and control boxes for the transmitters will not mate with their counterparts due to connector differences. It is interesting to note that the various receivers would also fit the SCR-274N and ATA transmitter racks which probably lead to the early (if not smelly) demise of a few receivers, and played a part in the design change for the ARC-5 transmitter rack.

The A.R.C. type 15 receivers will fit the Command set racks however the pin assignments are different necessitating some re-wiring. The Type 12 receivers and the TV-10 transvertor also fits however there is no rear connector on them nor is there any method to lock them in place. The modifications are very simple however and it does make for a convenient way to mount the units.

The various control boxes are usefull not only for controlling 'in type' equipment but also for other pieces. <There is a Type 12 installation that is more ARC-5 than Type 12, and an ARC-5 installation that has as its only ARC-5 piece one control box!> If a remote control function is needed, it might be worthwhile to look at the various boxes to see if the needed functions are on them.

The information on the following pages is from teh manuals, schematics and in some cases from the units themselves. There are no schematics- these are available from such sources as the nice people at Fair Radio Sales. What is here is some very basic info

on 'What is it?' and 'How do I make it work?'. There are equipment lists, pinouts, some VERY brief specs, connector lists, and a few quick hook-ups so you can light off the rig without too much fuss and bother.

Some pieces not in the Command and Type 12 series are included, and some that are parts of the various series are not here. The criteria for these two groups was availability- the former are generally available and the latter aren't.

Where possible, I included the A.R.C. part number for the various units, which provides a ready made cross-reference between the series. There are at the end a series of lists in numeric order to assist in this referencing.

The ATA/ARA and some pieces of the ARC-5 sets are identified by a five digit number. This is the numeric portion of the Navy accounting number of the item. The Navy accounting system is a method of uniquely identifying equipment and consists of a three letter and five digit code. The three letters (the first of which is always 'C') identifies the builder, with CBY (A.R.C.) and CCT (Stromberg-Carlson) being the ones most commonly found on the Command set units. The first two digits of the numeric portion identify the type of unit (46 for receivers, 52 for transmitters, etc with related pieces carrying the same type identifier) and the last three digits uniquely identify the particular unit. Note that a CBY-46104 receiver and a CCT-46104, for example, are the same receiver built by two different builders. For this reason, the builder code has been deleted from the following lists.

The builder code does appear on some, if not all, ARC-5 units on the identification plate after the serial number. On the other series, the builder's name often is on the identification plate at the bottom.

At some point or another, I hope to have an addendum covering items missed plus any added information that may be of use. Any assistance toward this end will be gratefully accepted, and will be acknowledged in the addendum. In the mean time, however, I would like to thank George Sellati at Fair Radio for his help (and for being tolerant of me!), Gordon Eliot White for getting me interested in A.R.C. through his many fine articles, and, of course, the Aircraft Radio Corporation for their excellent products which have brought many hours of pleasure.

## EQUIPMENT LISTS

The equipment lists are broken into four groups: SCR-274N & ATA/ARA, ARC-5, Type 12, and Miscellaneous. Some very minor specs are presented on the receivers and transmitters and, where possible, A.R.C.'s part number is given. To assist in locating a particular piece, the lists are broken into sections- Receivers, Transmitters, etc.

Receivers

| Freq Rng<br>(mHz) | Identification |      |            |      | IF<br>(kHz) | Sens<br>(uv) | Select(kHz) |      |
|-------------------|----------------|------|------------|------|-------------|--------------|-------------|------|
|                   | SCR-274N       |      | Navy (ARA) |      |             |              | 3db         | 10db |
|                   | Mil            | ARC# | Mil        | ARC# |             |              |             |      |
| .19 - .55         | BC-453         | 7594 | 46129      | 7839 | 85          | 7            | 1.7         | 3.1  |
| .52 - 1.5         | BC-946         |      | 46145      | 5950 | 239         | 8            | 2.9         | 4.9  |
| 1.5 - 3.0         | --             | --   | 46104      | 5005 | 705         | 6            | 3.9         | 6.4  |
| 3.0 - 6.0         | BC-454         | 7595 | 46105      | 5006 | 1415        | 7            | 7.5         | 12.5 |
| 6.0 - 9.1         | BC-455         | 7596 | 46106      | 5007 | 2830        | 8            | 9.8         | 24.2 |

Transmitters

| Freq Rng<br>(mHz) | Identification |      |            |      | Power<br>In(W) |
|-------------------|----------------|------|------------|------|----------------|
|                   | SCR-274N       |      | Navy (ATA) |      |                |
|                   | Mil            | ARC# | Mil        | ARC# |                |
| 2.1 - 3.0         | --             | --   | 52232      | 7916 | 89             |
| 3.0 - 4.0         | BC-696         |      | 52208      | 5009 | 88             |
| 4.0 - 5.3         | BC-457         | 7632 | 52209      | 5010 | 88             |
| 5.3 - 7.0         | BC-458         | 7633 | 52210      | 5011 | 90             |
| 7.0 - 9.1         | BC-459         | 7634 | 52211      | 5012 | 90             |

Accessories

| Item Name       | Identification |       |      | Notes                                      |
|-----------------|----------------|-------|------|--|
|                 | SCR-274N       | Navy  | ARC# |  |
| Modulator       | BC-456         | 50083 | 7591 | ARC # for Navy is 5013                     |
| Antenna Relay   | BC-442         | 29125 | 5017 |  |
| Dynamotor, Rec  | DM-32          | 21531 | 7351 | 250v, 60ma                                 |
| Dynamotor, Tran | DM-33          | 21626 | 5168 | 575v, 160ma contin<br>540v, 250ma intermit |
| Adapt., Rem Ctl | FT-230         | 49107 | 6433 | For Inst. Land. Sys.                       |
| Adaptor, Power  | FT-310         | 62036 | 9074 |  |
| Adapt., Lcl Ctl | FT-260         | -     | 6434 |  |

Control Boxes

| Function    | Identification |       |      |
|-------------|----------------|-------|------|
|             | SCR-274N       | Navy  | ARC# |
| Transmitter | BC-451         | 23243 | 7095 |
| 1 Receiver  | BC-473         | 23261 | 7043 |
| 2 Receivers | BC-496         | 23155 | 6546 |
| 3 Receivers | BC-450         | 23251 | 5014 |

## Racks and Mounts

### Trans & Rec

| # | Units | <u>Identification- Rec</u> |             |             | <u>Identification-Trans</u> |             |             |
|---|-------|----------------------------|-------------|-------------|-----------------------------|-------------|-------------|
|   |       | <u>SCR-274N</u>            | <u>Navy</u> | <u>ARC#</u> | <u>SCR-274N</u>             | <u>Navy</u> | <u>ARC#</u> |
| 1 | Mount | FT-231                     | -           | 7059        | FT-232                      | -           | 7061        |
|   | Rack  | FT-233                     | -           | 7509        | FT-234                      | -           | 7507        |
| 2 | Mount | FT-279                     | 46085       | 5694        | FT-227                      | 52213       | 7062        |
|   | Rack  | FT-277                     | 46110       | 5018        | FT-226                      | 52212       | 5020        |
| 3 | Mount | FT-221                     | 46150       | 7060        | FT-262                      | -           | 7063        |
|   | Rack  | FT-220                     | 46149       | 7537        | FT-276                      | -           | 7638        |
| 4 | Mount | FT-278                     | -           | 5696        | FT-332                      | -           | 7064        |
|   | Rack  | FT-264                     | -           | 5019        | FT-331                      | -           | 6090        |

### Other Mounts

| <u>Unit Mounted</u> | <u>Identification</u> |             |             |
|---------------------|-----------------------|-------------|-------------|
|                     | <u>SCR-274N</u>       | <u>Navy</u> | <u>ARC#</u> |
| Modulator           | FT-225                | 50084       | 7058        |
| Antenna Relay       | FT-229                | 29126       | 7056        |
| Ctl Box, Trans      | FT-228                | *           | 7083        |
| Ctl Box, 1 Rec      | FT-235                | *           | 7053        |
| Ctl Box, 2 Rec      | FT-240                | *           | 6831        |
| Ctl Box, 3 Rec      | FT-222                | *           | 7054        |

## Miscellaneous

| <u>Item Name</u>  | <u>Identification</u> |             |             | <u>Notes</u>            |
|-------------------|-----------------------|-------------|-------------|-------------------------|
|                   | <u>SCR-274N</u>       | <u>Navy</u> | <u>ARC#</u> |                         |
| Dial, .19-.55 mHz | MC-214                | *           | 6051        | For ctl boxes           |
| Dial, .52-1.5 mHz | MC-415                | *           | 6052        | " " "                   |
| Dial, 1.5-3.0 mHz | --                    | *           | 7575        | " " "                   |
| Dial, 3.0-6.0 mHz | MC-213                | *           | 6053        | " " "                   |
| Dial, 6.0-9.1 mHz | MC-212                | *           | 6054        | " " "                   |
| Wired Plug        | PL-192                | -           | 6787        | Used with Lcl Ctl Adpt. |
| Kit, Tuning Shaft | MC-215                | *           | 6151        |                         |
| Knob, Lcl Tuning  | MC-237                | -           | 6743        | Also MC-236             |
| Adaptor, Rt angle | Mc-211                | -           | 6357        | For tuning shaft        |

\* designates no unique identification assigned to this piece.

Receivers

| Freq Rng<br>(mHz) | Ident |       | IF<br>(kHz) | Sens<br>(uv) | Select(kHz) |      |           |
|-------------------|-------|-------|-------------|--------------|-------------|------|-----------|
|                   | ARC-5 | ARC#  |             |              | 3db         | 10db |           |
| .19 - .55         | R-23  | 9602  | 85          |              |             |      |           |
| .19 - .55         | R-23A | 10007 | 85          | 5            | 1.1         | 2.2  |           |
| .19 - .55         | R-148 | 10008 | 85          | 5            | 1.1         | 2.2  | *12v Fil. |
| .52 - 1.5         | R-24  | 9603  | 239         | 7            | 2.1         | 4.0  |           |
| 1.5 - 3.0         | R-25  | 9604  | 705         | 7            | 3.2         | 6.0  |           |
| 3.0 - 6.0         | R-26  | 9605  | 1415        | 6            | 7.3         | 13.0 |           |
| 6.0 - 9.1         | R-27  | 9606  | 2830        | 6            | 13.0        | 26.0 |           |
| 100 - 156         | R-28  |       | 12mHz       |              |             |      |           |

Transmitters

| Freq Rng<br>(mHz) | Identification |       |      | Power<br>In(W) |
|-------------------|----------------|-------|------|----------------|
|                   | ARC-5          | Navy  | ARC# |                |
| .50 - .80         | T-15           | 52302 | 9315 |                |
| .80 - 1.3         | T-16           | 52303 | 9316 |                |
| 1.3 - 2.1         | T-17           | 52304 | 9317 |                |
| 2.1 - 3.0         | T-18           | 52305 | 9308 | 106            |
| 3.0 - 4.0         | T-19           | 52306 | 9309 | 102            |
| 4.0 - 5.3         | T-20           | 52307 | 9310 | 107            |
| 5.3 - 7.0         | T-21           | 52308 | 9311 | 96             |
| 7.0 - 9.1         | T-22           | 52309 | 9312 | 99             |
| 100 - 156         | T-23           |       |      |                |

Accessories

| Item Name       | Ident |       | Notes                                      |
|-----------------|-------|-------|--|
|                 | ARC-5 | ARC#  |  |
| Modulator       | MD-7  | 9313  | Navy Acct'g # is 50141                     |
| Antenna Relay   | RE-2  | 5017  |  |
| Antenna Tuner   | TN-6  | 9607  |  |
| Dynamotor, Rec  | DY-1  |       | 250v, 60ma, 12v in                         |
| "               | DY-2A | 7351  | " " 24v in                                 |
| "               | DY-2B | 10009 | " " "                                      |
| Dynamotor, Tran | DY-8  | 5168  | 575v, 160ma contin<br>540v, 250ma intermit |
| Adapt., Rem Ctl | MX-21 | 6433  |  |
| Adaptor, Power  | MX-20 | 9074  | For Inst. Land. Sys.                       |
| Adapt., Lcl Ctl | C-24  | 6434  |  |
| Adaptor, Audio  | MX-19 | 9595  |  |

### Control Boxes

| Controlled Function | Ident |      | Notes  |
|---------------------|-------|------|--|
|                     | ARC-5 | ARC# |  |
| Femote Ant/Loop Sw  | C-25  |      | Via mech. link to rec.   |
| 1 Rec, Tuneable     | C-26  | 9601 |  |
| 1 Rec, Lock-tuned   | C-27  | 9850 |  |
| HF Transmitters     | C-29  | 7314 |  |
| HF Trans, VHF Chan  | C-30  |      | Push-button Tr, Ch sel   |
| HF Trans, VHF Chan  | C-30A | 9910 | Rotary Tran, Chan sel  |
| Main Ctl Box        | C-38  | 9610 | Recs: 2 HF lock-tuned,<br>1 VHF, 1 ARR-2,<br>Trans & Rec Audio |
| Auxiliary Ctl Box   | C-39  | 9901 | ICS/Radio Sel, T & R Audio                                     |
| 1 Rec, VHF          | C-42  |      |  |
| 3 Rec, 2 HF & 1 VHF | C-43  |      | HF Rec are Tuneable  |
| Auxiliary Ctl Box   | C-48  | 9902 | As C-39, Has Mic Relay   |
| 1 Rec, Tuneable     | C-125 | 9911 | Panel Mount, Like C-26   |
| 1 Rec, Tuneable LF  | C-744 |      | New Panel Mt, No BFO Ctl                                       |

### Jack & Junction Boxes

| Function            | Ident |      | Notes                                      |
|---------------------|-------|------|--|
|                     | ARC-5 | ARC# |  |
| Jack Box, Mic/Tel   | J-16  | 9905 | No Vol Ctl or Mic Relay                    |
| Junct Box, System   | J-17  | 9903 | For Multi-system Install.                  |
| Jack Box, Mic/Tel   | J-22  | 9867 | No Mic Relay                               |
| Jack Box, Mic/Tel   | J-22* | 9907 | Has Vol Ctl & Mic Relay                    |
| Ctl Split, VHF Chan | J-28  | 9609 | For C-30* to R-28 & T-23                   |
| Ctl Split, Trans    | J-34  | 9562 | For Multiple Trans Racks<br>On 1 Modulator |

### Packs & Mounts

#### Trans & Rec

| # Units | Ident-Rec |      | Ident-Trans |      |               |
|---------|-----------|------|-------------|------|---------------|
|         | ARC-5     | ARC# | ARC-5       | ARC# |               |
| 1 Mount | MT-5      | 7059 | MT-68       | 7061 |               |
| Rack    | MT-7A     | 7509 | MT-69       | 9306 |               |
| Rack    | MT-411    | 9202 | -           | --   | Wired for 12v |
| 2 Mount | MT-62     | 5694 | MT-70       | 7062 |               |
| Rack    | MT-63     | 5018 | MT-71       | 9307 |               |
| 3 Mount | MT-64     | 7060 | MT-72       | 7063 |               |
| Rack    | MT-65     | 7537 | MT-73       | 9593 |               |
| 4 Mount | MT-66     | 5696 | MT-74       | 7064 |               |
| Rack    | MT-67     | 5019 | MT-75       | 9394 |               |

Other Mounts

| Unit Mounted    | Ident  |      | Notes                             |
|-----------------|--------|------|-----------------------------------|
|                 | ARC-5  | ARC# |                                   |
| Modulator       | MT-76  | 7067 |                                   |
| Antenna Relay   | Mt-77  | 7065 |                                   |
| Antenna Tuner   | MT-159 | 7057 |                                   |
| Ctl & Jack Box  | MT-78  | 9451 | For C-27, J-16,-22,-22*           |
| Control Box     | MT-4   | 7053 | For C-26                          |
| Ctl & Junct Box | MT-80  | 7083 | For C-29,-30,-39,-48,<br>J-28,-34 |
| Control Box     | MT-98  | 7054 | For C-38,-43                      |
| Junction Box    | Mt-84  | 9904 | For J-17                          |

Miscellaneous

| Item Name            | Ident |      | Notes                     |
|----------------------|-------|------|---------------------------|
|                      | ARC-5 | ARC# |                           |
| Dial, .19 - .55 MHz  | ID-25 | 6051 | For tuneable Rec Ctl Box  |
| Dial, .52 - 1.5 MHz  | ID-26 | 6052 | " " " " "                 |
| Dial, 1.5 - 3.0 MHz  | ID-27 | 7575 | " " " " "                 |
| Dial, 3.0 - 6.0 MHz  | ID-28 | 6053 | " " " " "                 |
| Dial, 6.0 - 9.1 MHz  | ID-29 | 6054 | " " " " "                 |
| Wired Plug           | J-33  | 6787 | Used With Lcl Ctl Adaptor |
| Kit, Tuning Shaft    | *     | 6151 |                           |
| Knob, Lcl Tuning     | *     | 7643 |                           |
| Knob, Lcl Ant/Loop   | *     | 7491 |                           |
| Knob/Cap, Lock-tun'g | *     | 9554 |                           |
| Adaptor, Rt Angle    | MX-22 | 6357 | Used with Tuning Shaft    |

\* No unique identifier in ARC-5 system

Note: The following are components of the ARR-2 system that are used with the ARC-5 system: DY-1, DY-2A, DY-2B, MT-4, MT-5, MT-7A, MX-22.



Receivers

| Freq Rng<br>(mHz) | <u>Identification</u> |            | IF<br>(_Hz) | Sens<br>(uv) | Select(kHz) |       | Notes     |
|-------------------|-----------------------|------------|-------------|--------------|-------------|-------|-----------|
|                   | <u>Civilian</u>       | <u>Mil</u> |             |              | 6db         | 60db  |           |
| .19 - .55         | F-11(12v)             | F-510      | 85k         | 2            |             | 5.0   | 12v       |
|                   | R-11(24v)             | R-511      | 85k         | 2            |             | 5.0   | 24v       |
| .52 - 1.5         | R-10                  | -          | 239k        | 2            |             | 7.6   | 12 or 24v |
| 108 - 136         | R-15(12v)             | -          | 15m         | 2            | 100.        | 350.0 | 12v       |
|                   | R-15(24v)             | R-509      | 15m         | 2            | 100.        | 350.0 | 24v       |
| 118 - 148         | R-19(12v)             | R-507      | 15m         | 2            | 100.        | 350.0 | 12v       |
|                   | R-19(24v)             | R-508      | 15m         | 2            | 100.        | 350.0 | 24v       |

Transmitters

| Freq Rng<br>(mHz)       | <u>Identification</u> |            | Tubes<br>Used | Power<br>Out(w) | Notes     |
|-------------------------|-----------------------|------------|---------------|-----------------|-----------|
|                         | <u>Civilian</u>       | <u>Mil</u> |               |                 |           |
| 116 - 132               | T-11A                 | -          | 6AQ5          | 2               | 12 or 24v |
|                         | T-11B(12v)            | T-336      | 5763          | 2+              | 12v       |
|                         | T-11B(24v)            | T-366      | 5763          | 2+              | 24v       |
| 132 - 148<br>(see note) | T-13                  | -          | 6AQ5          | 2               | 12 or 24v |
|                         | T-13A(12v)            | T-363      | 5763          | 2+              | 12v       |
|                         | T-13A(24v)            | T-364      | 5763          | 2+              | 24v       |

Note: Freq may be lowered to 125 mHz by using capacity plates  
APC# 15392 for the T-13, and ARC# 15900 for the T-13A.

Dynamotors

D-10A(12v), ARC# 14480: 12v, 3.4a in, 250v, 85ma out  
D-10A(24v), APC# 14482: 24v, 1.7a in, 250v, 85ma out

Note: Dynaverter DV-10, -10A is later replacement

Junction & Jack Boxes

| <u>Item Name</u> | <u>Ident</u> | <u>Notes</u>       |
|------------------|--------------|--------------------|
| Jack Box         | J-10         | Aircrew Mic/Tel    |
| Junction Box     | J-12         | 32 Tie points, 12v |
| Junction Box     | J-13         | 32 Tie points, 24v |
| Junction Box     | J-15         | 56 Tie points, 24v |

### Control Boxes

| <u>Ctl'd Function</u>           | <u>Ident</u> | <u>Notes</u>  |
|---------------------------------|--------------|---|
| 1 Rec                           | C-16         | Dial for R-11A  |
| 1 Rec                           | C-17         | Dial for R-15   |
| Loop Heading                    | C-18         |   |
| 3 Rec, 2 Tran,<br>Loop Heading  | C-24         | 1 ea: R-10,-11,-15, 2 Type 12 Trans<br>Loop Heading, Panel Mount                                  |
| 3 Trans                         | C-25         | 2 Type 12, 1 Extern Trans   |
| 2 Rec, 3 Trans,<br>Loop Heading | C-36         | 1 ea: R-11,-19, 2 Type 12 trans,<br>1 Extern Trans, Loop Heading,<br>Panel Mount                  |
| 2 Pec, 3 Trans                  | C-37         | Like C-36, No Loop or Panel Mount   |
| 2 Rec, 3 Trans                  | C-38         | 1 ea: R-11,-15, 2 Type 12 Trans,<br>1 Extern Trans  |
| 2 Pec, 2 Trans<br>Loop Heading  | C-39         | As C-36, panel Mount, No Extern Trans   |
| 3 Pec, 3 Trans                  | C-40         | 1 ea: R-11,-19, Tuneable HF ARC-5 Rec,<br>1 ea: HF & VHF ARC-5 trans, Extern Trans<br>Panel Mount |
| 1 Rec, Loop Hdg                 | C-48         | Dial for R-11, Loop Heading, New Panl Mt  |
| 1 Rec, 4 Trans                  | C-56         | Dial for R-19, 3 Type 12 Trans, 1 Extern<br>Trans, Whistle-stop, New Panel Mount                  |

### Mounts

| <u>Unit Mounted</u> | <u>Ident</u> | <u>Notes</u>                     |
|---------------------|--------------|----------------------------------|
| 1 Transmitter       | M-11         |                                  |
| 1 Receiver          | M-12         |                                  |
| Control Box         | M-13         | For C-37,-38, Like ARC# 6831     |
| Control Box         | M-18         | For C-16,-17,-18, Like ARC# 7053 |
| Control Box         | M-19         | For C-25, Like ARC# 7083         |

### Miscellaneous

| <u>Item Name</u>  | <u>Ident</u> | <u>Notes</u>                                       |
|-------------------|--------------|--|
| Antenna, VHF      | A-12         | 3-Section Rod                                      |
| Antenna, Loop     | L-10         | 9" Dia, Mil: AT-382                                |
| Kit, Wire Antenna | -            | ARC# 12296   |
| Kit, Tuning Shaft | -            | ARC# 6151  |
| Wired Plug        | -            | ARC# 11934, Used when oper'g Rec<br>without Trans. |

### Related Equipment

#### SCR-274N, ATA/ARA

- Receiver Test Set-up, ARC# 7918 (Mil: RC-54A)  
Consists Of: 7369 Meter Panel, Single Rec Rack & Mount,  
Dynamotor, Tuning Knob, and Cables
- Transmitter Test Set-up, ARC# 7919 (Mil: RC-55A)  
Consists of: 7507 Meter Panel, Single Trans Rack & Mount,  
Modulator & Mount, Dynamotor, Ctl Box, Cables,  
and ARC# 7777 Dummy Ant. (Mil: A-61A)

## ARC-5

Receiver Test Set-up (as SCR-274N, ATA/ARA)

Transmitter Test Set-up, ARC# 9558

Consists of: 9556 Meter Panel, Crystals for 3, 4, 5.3,  
7, & 9.1 mHz and contents of ARC# 7919 Set-up.

R-4/ARR-2 Homing Receiver, 234-258 mHz

Includes: C-2/ARR-2 Ctl Box (if rec is used alone.)

MX-2/ARR-2 Wired Plug for Rec Rack

## A.R.C. Type 12

R-20 Fixed-tuned (75 mHz) Marker Beacon Rec

R-22 .55-1.5 mHz Rec (Like R-10 but later model)

R-836 .19-1.75 mHz ADF Rec, Part of ARN-59 System

Includes C-2275/ARN control Box

TV-10 (CV-431/AR) Transvertor

Trans: 228-258 mHz, Converts 228-258 mHz to 118-148 mHz Rec.

Type 15 Equipment (VOR/ILS Receiving Eq't)

R-13 (R-445/ARN-30) 108-136 mHz Rec.

R-34 (R-1021/ARN-30D) 108-126.9 mHz Crystal-ctl'd Rec

B-13 (CV-265/ARN-30) VOR/ILS Converter

E-14 (MT-1175/ARN-30) Equipment Rack

C-81,-88 Control Boxes For R-34

C-3436A/ARN-30 Ctl box for R-1021/ARN-30D

## PINOUTS

On the following few pages are pinouts for the connectors on most of the equipment previously listed. The same order of categories is preserved as used in the previous section however they are collected so that all the receivers are together, etc for the main equipment. The related equipment is still separate and at the end of the section.

Except for two cases, all the connectors are numbered anti-clockwise when viewed from the outside. The exceptions are the connectors on the rear of the rack-mounted receivers and transmitters, and those on the rear of the receiver adaptors.

The number in parenthesis is A.R.C.'s part number for the receptical in question. The 'Connectors' section following this one is ordered numerically on this number, and can be used to locate the proper plugs to match.

Notes are indicated by an astrisk and a one or two digit number (for example, \*4 or \*28.) The notes are at the end of the section. The number refers to a particular note.

An Astrisk used as a suffix to a unit's identifier means that all versions of the unit are being referenced. For example: J-22\* refers to the J-22, J-22A, and J-22B.

## Receivers

### Command Receivers (All Series)

J-1 (4724) To Adaptors \*8  
1 Gain Ctl                   4 Nav Audio \*1           7 +LV Source Out  
2 Gnd                        5 CW Shut-off           8 +HV Out  
3 n/c                         6 +LV to Rec

J-3,-102 (5488) To Rack  
1 Gnd                        4 CW Shut-off \*7       7 +HV out  
2 Audio Out                 5 +Vscr out \*8  
3 Gain Ctl                   6 +LV Source In

J-103 (5577) To Channel Select Ctl Box \*9  
1 Sel Chan A                3 Gnd                    5 Sel Chan D  
2 Sel Chan B                4 Sel Chan C            6 n/c

A.R.C. R-10,-11  
J-502,-602 (12427) To Primary Power Source  
A +LV Source In        B Gnd

J-503,-603 (11905) To Rec Ctl Box  
A Audio Out                C Gnd                   E Sens  
B Loop Relay               D +LV to Rec           F +LV Source Out

J-506,-606 (11905) To Transmitter \*2  
A +HV to Trans            C Gnd                   E +HV to Rec  
B Audio Out                D +LV to Trans           F n/c

A.R.C R-15,-19  
J-101,-301 (12427) To Primary Power Source  
A +LV Source In        B Gnd

J-102,-302 (11905) To Rec Ctl Box  
A Audio Out                C Gnd                   E Sens  
B Audio Hi-Lo             D +LV to Rec           F +LV Source Out

J-103,-303 (11905) To Transmitter \*2  
A +HV to Trans            C Gnd                   E +HV to Rec  
B Audio Out                D +LV to Trans           F n/c

## Transmitters

### SCR-274N, ATA

J-64 (5488) To Rack  
1 Gnd                        4 P.A. Vscr             7 P.A. B+  
2 P.A. Grid                 5 Select (key)  
3 Osc B+                    6 +LV In

## ARC-5

J-69,-308 (9302) To Rack  
 1 n/c                      4 Gnd                      7 P.A. B+  
 2 Osc B+                    5 +LV In  
 3 Select (key)              6 P.A. Vscr

J-79 (9849) To Antenna Tuner \*3  
 1 Select (key)              2 Gnd                      3 +LV Out

J-309 (7026) To Channel Select Control \*10  
 1 Sel Chan A                4 Gnd                      7 Voltage Reg.  
 2 Sel Chan B                5 Sel Chan D              8 n/c  
 3 Sel Chan C                6 Key

J-307 (6418) To Test Set \*10  
 1 Osc Ig                      4 Gnd                      7 +LV  
 2 1st H.G. Ig                5 P.A. Ig                  8 +HV  
 3 2nd H.G. Ig                6 P.A. Ik

A.R.C. T-11(),-13()  
 J-204,-404,-2302,-2402 (11905) To Rec  
 A +HV to Trans              C Gnd                      E +HV to Rec  
 B Rec Audio In              D +LV In                  F +LV Source

J-205,-405,2306,-2406 (12093) To Audio  
 A Mic In                      C Gnd  
 B Key                         D Tel Out \*4

J-207,-407,-2303,-2403 (12097) To Ctl Box  
 A Sel Chan 1                 D Gnd                      G +LV to Ctl Box  
 B " " 2                      E Sel Chan 4              H +LV In  
 C " " 3                      F " " 5                    \*5

Accessories

## Modulator (SCR-274N, ATA/ARA)

J-52 (5577) To Rec Rack  
 1 Sidetone Inject          3 Gnd                      5 Key  
 2 n/c                         4 n/c                      6 +LV

J-53 (7024) To Primary Power Source  
 1 +LV Source In              2 Gnd                      3 +LV Source In

J-54 (7027) To Control Box  
 1 Sel Trans 1                7 Gnd                      13 Modulator Cath.  
 2 " " 2                      8 Mic                      14 1000-cycle Off  
 3 " " 3                      9 Key                      15 +LV to Eq't  
 4 " " 4                      10 Voice Sidetone        16 Voltage Reg.  
 5 Meter +                    11 Tone Sidetone        17 Sidetone Inject  
 6 Meter -                    12 Dyn. Relay            18 +LV Source Out

Modulator (SCF-274N, ATA/ARA), Con't

J-58 (7025 To Trans Rack  
 1 Meter + 5 Gnd 9 Sel Trans 1  
 2 Meter - 6 Sel Trans 4 10 P.A. B+  
 3 Key 7 " " 3 11 Osc. B+  
 4 +LV 8 " " 2 12 P.A. Vscr.

Modulator (ARC-5)

J-52 (5577) To Rec Rack  
 1 Sidetone 1 3 Gnd 5 Key  
 2 A-Tel 4 B-Tel 6 +LV  
 J-53 (7024) To Primary Power Source  
 1 +LV Source In 2 Gnd 3 +LV Source In

J-70 (9417) To Trans Rack  
 1 +LV 5 Sel Trans 3 9 +HV  
 2 Sel Trans 1 6 " " 4 10 Osc. B+  
 3 " " 2 7 Key 11 Test Relay  
 4 Gnd 8 P.A. B+ 12 P.A. Vscr.

J-74 (7026) To External Equipment  
 1 Mic 4 Gnd 7 Key  
 2 A-Tel 5 Sidetone 1 8 +LV  
 3 B-Tel 6 Sidetone 2

J-78 (5571) To Ctl Box  
 1 Sel Trans 1 7 Gnd 13 Modulator Cath.  
 2 " " 2 8 Mic 14 1000-cycle Off  
 3 " " 3 9 Key 15 +LV To Eq't  
 4 " " 4 10 Voice Sidetone 16 Voltage Reg.  
 5 n/c 11 Tone Sidetone 17 Sidetone Inject  
 6 Sel Common 12 Dyn. Relay 18 +LV Source Out

Antenna Relay (All Series)

J-61 (7023) To Trans Rack  
 1 Key 3 Gnd 5 Meter -  
 2 Meter + 4 +LV In

Antenna Tuner (ARC-5)

J-1601,-1602 (9849) \*11  
 1 Key 2 Gnd 3 +LV In

Remote Ctl Adaptor (SCR-274N,ARA, ARC-5)

J-31 (6063) To Rec Adapt. Cavity  
 1 n/c 4 n/c 7 jmpr to 6  
 2 n/c 5 n/c 8 n/c  
 3 n/c 6 Jmpr to 7

Power Adaptor (SCR-274N,ARA,ARC-5)

J-29 (6036) To Rec Adapt. Cavity  
1 n/c                      4 n/c                      7 +LV (Jmpr to 6)  
2 Gnd                      5 n/c                      8 +HV  
3 n/c                      6 +LV (Jmpr to 7)

J-30 (2226) To External Eq't  
25 +LV                      27 Gnd                      36 n/c  
26 n/c                      35 +HV

Lcl Ctl Adaptor (SCR-274N, ARC-5)

J-32 (6962) To Rec Adapt. Cavity  
1 Gain Ctl                      4 n/c                      7 +LV to Rec  
2 Gnd                      5 CW Shut-off                      8 n/c  
3 n/c                      6 +LV Source

Audio Adaptor (ARC-5)

J-27 (6036) To Rec Adapt Cavity  
1 Gain Ctl                      4 Navig. Audio                      7 +LV (Jmpr to 6)  
2 Gnd                      5 CW Shut-off                      8 n/c  
3 n/c                      6 +LV (Jmpr to 7)

J-28 (9336) to External Eq't  
1 Audio                      2 Gnd                      3 Relay Ctl

Control Boxes (SCR-274N, ATA/ARA)

Transmitter Ctl Box

J-55 (7027) To Modulator  
1 Sel Trans 1                      7 Gnd                      13 Modulator Cath.  
2 " " 2                      8 Mic                      14 1000-cycle Off  
3 " " 3                      9 Key                      15 +LV to Eq't  
4 " " 4                      10 Voice Sidetone                      16 Voltage Regulator  
5 Meter +                      11 Tone Sidetone                      17 Sidetone Inject  
6 Meter -                      12 Dyn. Relay                      18 +LV Source

J-56 (2674) To External Meter  
+ Meter +                      (blank) Meter -

Receiver Ctl Boxes (Single or Multi.)

J-25,-26,-27 (6418) To Rec Rack  
1 +LV Source                      4 Gnd                      7 CW Shut-off  
2 Rec Audio                      5 B-Tel                      8 A-Tel  
3 Gain Ctl                      6 +LV to Rec

Control Boxes (ARC-5)

Single Rec, Tuneable (C-26)

J-4 (6418) To Rec Rack  
1 +LV Source 4 Gnd 7 CW Shut-off  
2 Rec Audio 5 B-Tel 8 A-Tel  
3 Gain Ctl 6 +LV To Rec \*13

Single Rec, Lock-tuned (-27)

J-5 (9835) To Rec Rack  
1 Gain Ctl 2 Gnd

HF Trans Ctl (C-29)

J-77 (5571) To Modulator  
1 Sel Trans 1 7 Gnd 13 Modulator Cath.  
2 " " 2 8 n/c 14 1000-cycle Off  
3 " " 3 9 Key 15 +LV to Eq't  
4 " " 4 10 Voice Sidetone 16 Voltage Reg.  
5 n/c 11 Tone Sidetone 17 Sidetone Inject  
6 Sel Common 12 Dyn. Relay 18 +LV Source

HF Trans & VHF Chan Sel (C-30,-30A)

J-402,-1700 (5571) To Modulator  
- Pinout same as J-77 on C-29 above)

J-401,-1701 (7025) To VHF Eq't

1 Trans Chan A 5 Gnd 9 Rec Chan C  
2 " " B 6 Key 10 " " D  
3 " " C 7 Rec Chan A 11 Voltage Reg  
4 " " D 8 " " B 12 n/c

Main Ctl Box (C-38)

J-1001 (7027) To Eq't or Junct. Box J-17  
1 Sens(VHF) 7 Gnd 13 Sens(ARB)  
2 Sens(HF) 8 Key(MHF) 14 Pitch(ARR-2)  
3 Mic Inp(MHF) 9 Key(VHF) 15 Key(Pilot)  
4 Mic Inp(VHF) 10 CW S-0(ARR-2) 16 Key(ICS)  
5 Mic Inp(ICS) 11 Audio(Pilot) 17 Sens(ARR-2)  
6 Mic(Pilot) 12 Audio Buss 18 Audio(VHF)

Auxiliary Ctl Box (C-39,-48) \*14

J-1101,-1102 (7025) To Eq't or Junct. Box J-17  
1 Audio(ICS) 5 Gnd 9 Key(VHF)  
2 Audio Buss 6 Mic Inp(HF) 10 n/c  
3 Key(ICS) 7 Mic Inp(VHF) 11 Key(HF)  
4 n/c 8 Mic Inp(ICS) 12 +LV

J-1103 (9336) To External Key

1 n/c 2 Gnd 3 Key



VHF Rec Ctl Box (C-42)

|                          |              |           |
|--------------------------|--------------|-----------|
| J-460 (6418) To Rec Rack |              |           |
| 1 +LV Source             | 4 Gnd        | 7 AVC Ctl |
| 2 Rec Audio              | 5 B-Tel      | 8 A-Tel   |
| 3 MVC (Gain Ctl)         | 6 +LV To Rec |           |

J-463 (2674) To Rec Rack (J-6 or J-7)  
+, (blank) Rec Audio (shell) Gnd

HF & VHF Rec Ctl (C-43)

|  |              |               |
|--|--------------|---------------|
| J-410, -411 (6418) To Rec Rack, HF Rec Positions |              |               |
| 1 +LV Source                                     | 4 Gnd        | 7 CW Shut-off |
| 2 Rec Audio                                      | 5 B-Tel      | 8 A-Tel       |
| 3 Gain Ctl                                       | 6 +LV to Rec |               |

J-412 (6418) To Rec Rack, VHF Position  
-Pinout as J-460 on C-42 above-

J-413 (2674) To Rec Rack (J-6 or J-7)  
+, (blank) VHF Audio (shell) Gnd

Single Rec, Tuneable (C-125)

|                           |              |               |
|---------------------------|--------------|---------------|
| J-1900 (6418) To Rec Rack |              |               |
| 1 +LV Source              | 4 Gnd        | 7 CW Shut-off |
| 2 n/c                     | 5 n/c        | 8 n/c         |
| 3 Gain Ctl                | 6 +LV to Rec | *13           |

Single Rec, LF Tuneable (C-744)

|                           |       |       |
|---------------------------|-------|-------|
| J-1900 (6418) To Rec Rack |       |       |
| 1 n/c                     | 4 Gnd | 7 n/c |
| 2 Panel Lights            | 5 n/c | 8 n/c |
| 3 Gain Ctl                | 6 n/c |       |

Control Boxes (Type 12)

Single Rec, LF (C-16)

|                      |              |              |
|----------------------|--------------|--------------|
| J-701 (11905) to Rec |              |              |
| A n/c                | C Gnd        | E Sens       |
| B Ant/Loop Sw        | D +LV to Rec | F +LV Souree |

Single Rec, VHF (C-17)

|                      |              |              |
|----------------------|--------------|--------------|
| J-801 (11905) To Rec |              |              |
| A n/c                | C Gnd        | E Sens       |
| B Audio Hi-Lo        | D +LV to Rec | F +LV Source |

3 Rec, 2 Trans, Loop (C-24)

J-1001 (12096) To Eq't or Junct. Box  
 A Sel Chan 1 H Sel Trans 2 O Sens (Rnge)  
 B " " 2 I Chan Sel Common P Ant/Loop (Rnge)  
 C " " 3 J +LV (VHF) Q Sens (Bcst)  
 D " " 4 K +LV (Rnge) R Ant/Loop (Bcst)  
 E " " 5 L +LV (Bcst) S n/c  
 F Mic Key M Sens (VHF)  
 G Sel Trans 1 N Audio Hi-Lo (VHF)

J-1002 (12093) To Primary Power Source

A +LV Source B Gnd  
 C " " D "

3 Trans (C-25)

J-1101 (12096) To Eq't or Junct. Box  
 A Sel Chan 1 H Gnd O Mic Audio  
 B " " 2 I Trans Sidetone P Mic Key  
 C " " 3 J Mic Audio (Tr 2) Q Gnd  
 D " " 4 K Key (Trans 2) R Tel  
 E " " 5 L Rec Audio S n/c  
 F Mic Audio (Tr 1) M Mic Audio (Ext Tr)  
 G Key (Trans 1) N Key (Extern Trans)

2 Rec, 3 trans, (Loop) (C-36, -37, -38)

J-901, -1601, -2601 (12096) To Eq't or Junct Box  
 A Sel Chan 1 H Key (Tran 2) O Mic (tran 1 & 2)  
 B " " 2 I Key (Extrn Tran) P Mic (Extrn Tran)  
 C " " 3 J Rng/VHF Audio Q n/c  
 D " " 4 K Tel (Junct. Box) R n/c  
 E " " 5 L Sidetone (Tr1&2) S n/c  
 F Relay (Junct Box) M Key (Junct Box) \*15  
 G Key (Tran 1) N Mic (Junct Box)

J-902, -1602, -2602 (12097) To Eq't or Junct Box

A Sens (Rnge) D Sens (VHF) G +LV Source  
 B Ant/Loop Sw (Rng) E Hi-Lo Audio (VHF) H Gnd  
 C +LV (Rnge) F +LV (VHF)

2 Rec, 2 Trans, Loop (C-39)

J\_1701 (12096) To Eq't or Junct Box  
 A Sel Chan 1 H Sel Tran 2 O Sens (rng)  
 B " " 2 I n/c P Ant/Loop (Rnge)  
 C " " 3 J +LV (VHF) Q n/c  
 D " " 4 K +LV (Rnge) R n/c  
 E " " 5 L n/c S n/c  
 F Mic Key M Sens (VHF)  
 G Sel Trans 1 N Audio Hi-Lo (VHF)

J-1702 (12093) To Primary Power Source

A +LV Source C Gnd  
 B +LV Source D Gnd

3 Rec, 3 Trans (C-40)

J-1801 (12096) To Eq't or Junct Box  
A ARC-5 VHF Ch A H Relay (Junct Box) O Tel Out (Extrn)  
B " " " B I Tel Set P +LV to ARC-5 Trans  
C " " " C J Sidetone Q +LV Source  
D " " " D K Rec Tel Out R " "  
E Sel Trans (VHF) L Key (Extrn Tran) S Gnd  
F " " (HF) M Key (ARC-5)  
G " " Common N Key (Mic)

J-1802 (12097) To Eq't Or Junct Box

A +LV (ARC-5 Rec) D Sens (R-11) G Sens(R-19)  
B Sens (ARC-5 Rec) E Ant/Loop (R-11) H Audio Hi-Lo (R-19)  
C +LV (R-11) F +LV (F-19)

1 Rec, Loop (C-48)

J-a (12097) To Eq't \*16  
A Panel Lights D +LV to Rec G n/c  
B Ant/Loop Sw E Sens H n/c  
C Gnd F +LV Source

1 Rec, 4 Trans (C-56)

J-a (12096) To Eq't or Junct. Box  
A Sel Chan 1 H Mic (Trans 2) O +LV to Eq't  
B " " 2 I Mic (Trans 3) P Sens (Top of Pot)  
C " " 3 J Key In Q Mic (Trans 4)  
D " " 4 K Key (Trans 1) R Sens (Pot Tap)  
E " " 5 L Key (Trans 2) S Whistle Stop  
F Mic In M Key (Trans 3) \*17  
G Mic (Trans 1) N Chan Sel (Trans 4)

J-b (12093) To Eq't or Junction Box

A +LV Source C Gnd  
B Sel Trans 4 D Panel Lights

### Junction & Jack Boxes (ARC-5)

Jack Box, Mic/Tel (J-16,-22) \*14

J-1201 (9336) To Mic  
1 Mic 2 Key 3 Gnd

J-1202 (7026) To Junct Box J-17

1 Mic 4 Gnd 7 Key  
2 Audio 5 n/c 8 +LV In \*18  
3 n/c 6 n/c

System Junction Box (J-17)

|  |              |  |                  |
|--|--------------|--|------------------|
| J-1301 (6418) To ARC-5 VHF Rec               |              |  |                  |
| 1 n/c  | 4 Gnd        |  | 7 AVC Ctl        |
| 2 Rec Audio                                  | 5 n/c        |  | 8 n/c            |
| 3 Sens                                       | 6 +LV to Rec |  |                  |
| J-1302 (6418) To ARB MHF/HF Rec              |              |  |                  |
| 1 n/c  | 4 Gnd        |  | 7 CW Shut-off    |
| 2 Rec Audio                                  | 5 CW Gain    |  | 8 AVC            |
| 3 Sens                                       | 6 +LV to Rec |  |                  |
| J-1303(6418) T ARC-5 HF Rec                  |              |  |                  |
| 1 n/c  | 4 Gnd        |  | 7 CW Shut-off    |
| 2 Rec Audio                                  | 5 B-Tel      |  | 8 n/c            |
| 3 Sens                                       | 6 +LV to Rec |  |                  |
| J-1304(6418) To R-4/APR-2 Rec                |              |  |                  |
| 1 n/c  | 4 Gnd        |  | 7 CW Shut-off    |
| 2 Sens                                       | 5 Rec Audio  |  | 8 n/c            |
| 3 Pitch                                      | 6 +LV to Rec |  |                  |
| J-1305 (7024) to Modulator                   |              |  |                  |
| 1 +LV Source Out                             | 2 Gnd        |  | 3 +LV Source Out |
| J-1306 (7026) To HF Trans                    |              |  |                  |
| a) ARC-5 Trans                               |              |  |                  |
| 1 Mic  | 4 Gnd        |  | 7 Key            |
| 2 A-Tel                                      | 5 Sidetone 1 |  | 8 +LV            |
| 3 B-Tel                                      | 6 Sidetone 2 |  |                  |
| b) ART-13 Trans                              |              |  |                  |
| 1 n/c  | 4 Gnd        |  | 7 n/c            |
| 2 n/c  | 5 Mic        |  | 8 n/c            |
| 3 Key  | 6 Sidetone   |  |                  |
| J-1307 (6418) Test or as spec.               |              |  |                  |
| 1 n/c  | 4 Gnd        |  | 7 n/c            |
| 2 Audio                                      | 5 n/c        |  | 8 n/c            |
| 3 n/c  | 6 +LV Out    |  |                  |
| J-1308 (6418) To ARC-1 or ARC-4              |              |  |                  |
| 1 +LV  | 4 Gnd        |  | 7 n/c            |
| 2 Audio                                      | 5 Mic        |  | 8 Key            |
| 3 Gnd  | 6 +LV        |  |                  |
| J-1309 (7024) To Primary Power Source        |              |  |                  |
| 1 +LV Source In                              | 2 Gnd        |  | 3 +LV Source In  |
| J-1310 (7026) To Mic/Tel Jack Box (J-16,-22) |              |  |                  |
| 1 Mic  | 4 Gnd        |  | 7 Key            |
| 2 Audio                                      | 5 n/c        |  | 8 +LV            |
| 3 n/c  | 6 n/c        |  |                  |

System Junction Box (J-17) con't

J-1311 (7025) To Auxiliary Ctl Box (C-39,-48)

|               |             |              |
|---------------|-------------|--------------|
| 1 Audio (ICS) | 5 Gnd       | 9 Key        |
| 2 Audio Buss  | 6 Mic (MHF) | 10 n/c       |
| 3 Key (ICS)   | 7 Mic (VHF) | 11 Key (MHF) |
| 4 n/c         | 8 Mic (ICS) | 12 +LV       |

J-1312 (7027) To Main Ctl Box (C-38)

|               |                   |                  |
|---------------|-------------------|------------------|
| 1 Sens (VHF)  | 7 Gnd             | 13 Sens (ARB)    |
| 2 Sens (MHF)  | 8 Key (MHF)       | 14 Pitch (ARR-2) |
| 3 Mic (MHF)   | 9 Key (VHF)       | 15 Key (Pilot)   |
| 4 Mic (VHF)   | 10 CW S-O (ARR-2) | 16 Key (ICS)     |
| 5 Mic (ICS)   | 11 Audio (Pilot)  | 17 Sens (ARR-2)  |
| 6 Mic (Pilot) | 12 Audio Buss     | 18 Audio (VHF)   |

J-1313 (6418) To RL-7,-9 or Cat ICS

a) RL-7,-9

|         |          |       |
|---------|----------|-------|
| 1 n/c   | 4 Gnd    | 7 n/c |
| 2 Audio | 5 Mic In | 8 n/c |
| 3 n/c   | 6 +LV    |       |

b) Cat ICS

|       |          |         |
|-------|----------|---------|
| 1 n/c | 4 Gnd    | 7 Audio |
| 2 n/c | 5 Mic In | 8 n/c   |
| 3 n/c | 6 +LV    |         |

Ctl Split, VHF Chan. (J-28)

J-1401 (7025) To Ctl Box C-30,-30A

|                |              |                 |
|----------------|--------------|-----------------|
| 1 Trans Chan A | 5 Gnd        | 9 Rec Chan C    |
| 2 " " B        | 6 Key        | 10 " " D        |
| 3 " " C        | 7 Rec Chan A | 11 Voltage Reg. |
| 4 " " D        | 8 " " B      | 12 n/c          |

J-1402 (7026) To VHF Trans (T-23)

|                |                |                |
|----------------|----------------|----------------|
| 1 Trans Chan A | 4 Gnd          | 7 Voltage Reg. |
| 2 " " B        | 5 Trans Chan D | 8 n/c          |
| 3 " " C        | 6 Key          |                |

J-1403 (5577) To VHF Rec (R-28)

|              |               |              |
|--------------|---------------|--------------|
| 1 Rec Chan A | 3 Gnd         | 5 Rec Chan D |
| 2 " " B      | 4 Rec. Chan C | 6 n/c        |

Ctl Split, Multi Trans Rack (J-34)

J-1501,-1502,-1503 (9417) To Modulator & Trans Racks \*19

|               |               |               |
|---------------|---------------|---------------|
| 1 +LV         | 5 Sel Trans 3 | 9 +HV         |
| 2 Sel Trans 1 | 6 " " 4       | 10 Osc. B+    |
| 3 " " 2       | 7 Key         | 11 Test Relay |
| 4 Gnd         | 8 P.A. B+     | 12 P.A. Vscr  |

## Racks

### Receiver Racks, Command Set (All Series)

J-6,-7,-601,-602 (5577) To Modulator \*6

|              |         |       |
|--------------|---------|-------|
| 1 Sidetone 1 | 3 Gnd   | 5 Key |
| 2 A-Tel      | 4 B-Tel | 6 +LV |

J-18,-19,-20,-31,-603 (5842) To Rec

|             |                  |       |
|-------------|------------------|-------|
| 1 Gnd       | 4 CW Shut-off *7 | 7 n/c |
| 2 Rec Audio | 5 n/c            |       |
| 3 Gain Ctl  | 6 +LV To Rec     |       |

J-21,-22,-23,-32,-605 (6418) To Ctl Box

|              |              |                  |
|--------------|--------------|------------------|
| 1 +LV Source | 4 Gnd        | 7 CW Shut-off *7 |
| 2 Rec Audio  | 5 B-Tel      | 8 A-Tel          |
| 3 Gain Ctl   | 6 +LV to Rec |                  |

J-24,-604 (6485) To Primary Power Source

|                 |       |
|-----------------|-------|
| 1 +LV Source In | 2 Gnd |
|-----------------|-------|

### Trans Racks (SCR-274N,ATA)

J-59 (7025) To Modulator

|           |                |               |
|-----------|----------------|---------------|
| 1 Meter + | 5 Gnd          | 9 Sel Trans 1 |
| 2 Meter - | 6 Sel. Trans 4 | 10 P.A. B+    |
| 3 Key     | 7 " " 3        | 11 Osc. B+    |
| 4 +LV     | 8 " " 2        | 12 P.A. Vscr  |

J-60 (7023) To Antenna Relay

|           |       |           |
|-----------|-------|-----------|
| 1 Key     | 3 Gnd | 5 Meter - |
| 2 Meter + | 4 +LV |           |

J-62,-63,-67,-68 (5842) to Trans

|           |                |           |
|-----------|----------------|-----------|
| 1 Gnd     | 4 P.A. Vscr    | 7 P.A. B+ |
| 2 n/c     | 5 Select (Key) |           |
| 3 Osc. B+ | 6 +LV          |           |

### Trans Racks ARC-5)

J-56 (2674) To Extern Ant Meter

|           |                 |
|-----------|-----------------|
| + Meter + | (blank) Meter - |
|-----------|-----------------|

J-60 (7023) To Antenna Relay

|           |       |           |
|-----------|-------|-----------|
| 1 Key     | 3 Gnd | 5 Meter - |
| 2 Meter + | 4 +LV |           |

J-67,-68,-80,-82 (9296) To Trans

|                |             |           |
|----------------|-------------|-----------|
| 1 +HV          | 4 Gnd       | 7 P.A. B+ |
| 2 Osc. B+      | 5 +LV       |           |
| 3 Select (Key) | 6 P.A. Vscr |           |

Trans Racks (ARC-5) con't

J-71 (9417) To Modulator

|               |             |   |               |
|---------------|-------------|---|---------------|
| 1 +LV         | 5 Sel Trans | 3 | 9 +HV         |
| 2 Sel Trans 1 | 6 " "       | 4 | 10 Osc. B+    |
| 3 " " 2       | 7 Key       |   | 11 Test Relay |
| 4 Gnd         | 8 P.A. B+   |   | 12 P.A. Vscr  |

Related Equipment (ARC-5) \*20

R-4/ARR-2 Homing Rec

J-402 (5488) To Rack \*21

|             |          |       |
|-------------|----------|-------|
| 1 Gnd       | 4 n/c    | 7 n/c |
| 2 Rec Audio | 5 n/c    |       |
| 3 n/c       | 6 +LV In |       |

J-104 (6418) To Control Box

|              |              |                 |
|--------------|--------------|-----------------|
| 1 +LV Source | 4 Gnd        | 7 CW Shut-off   |
| 2 Sens       | 5 Rec Audio  | 8 Tel (To Rack) |
| 3 Pitch      | 6 +LV TO Rec |                 |

C-2/ARR-2 Control Box for R-4/ARR-2

|              |              |                 |
|--------------|--------------|-----------------|
| 1 +LV Source | 4 Gnd        | 7 CW Shut-off   |
| 2 Sens       | 5 Rec Audio  | 8 Tel (to Rack) |
| 3 Pitch      | 6 +LV to Rec |                 |

Related Equipment (Type 12)

TV-10 (CV-431/AR) Transverter

J4202 ( ) To Chan Sel Ctl \*23

|              |              |                   |
|--------------|--------------|-------------------|
| A Sel Chan 1 | E Sel Chan 5 | I UHF/VHF Sel     |
| B " " 2      | F " " 6      | J Whistle-thru    |
| C " " 3      | G " " 7      | K Gnd             |
| D " " 4      | H " " 8      | L Hi-Lo Freq Rnge |

J-4203 ( ) To Set Ctl \*24

|              |                   |               |
|--------------|-------------------|---------------|
| A +LV Source | E Key             | I UHF/VHF Sel |
| B +HV In     | F VHF Ant Disable | J n/c         |
| C +HV to VHF | G Sidetone        | K Gnd         |
| D Mic        | H Whsl-thru (VHF) | L n/c         |

R-20 Marker Beacon Rec

J-2702 (11905) To Ctl

|              |          |             |
|--------------|----------|-------------|
| A +HV to Rec | C Gnd    | E Relay Out |
| B Rec Audio  | D +LV In | F n/c       |

R-22 Rec, Broadcast

J-4803 ( ) To Ctl

|                |               |       |
|----------------|---------------|-------|
| A +LV to Rec   | E Sens        | I n/c |
| B +HV to Rec   | F Ant/Loop Sw | J n/c |
| C +HV to Trans | G Rec Audio   | K Gnd |
| D Gnd          | H n/c         | L n/c |

R-13 (R-445/ARN-30) Type 15 VOR/ILS Rec

J-103 ( ) To Equipment Rack \*25  
1 Gnd 4 Tuning Meter 7 +HV Out  
2 Rec Audio 5 Navig Audio  
3 Gain Ctl 6 +LV Source In

J-105 (11905) To Trans \*2,26

A +HV To Trans C Gnd E +HV to Rec  
B Rec Audio D +LV to Trans F n/c

F-34 (F-1021/ARN-30D) Type 15 VOR/ILS Rec

J-2 (12357) To Control  
A n/c H mHz Tuning Ctl O .1 mHz Tun'g Ctl  
B n/c I " " " P " " " "  
C n/c J " " " Q " " " "  
D n/c K " " " R " " " "  
E Local Squelch L " " " S Gnd  
F Squelch Circuit M Localizer Key  
G n/c N .1 mHz Tun'g Ctl

J-3 (11905) To Trans \*2

A +HV to Trans C Gnd E +HV to Rec  
B Rec Audio D +LV to Trans F Rem. Squelch Ctl

J-4 ( ) To Rack \*25

1 Gnd 4 Tuning Meter 7 +HV Out  
2 Rec Audio 5 Navig Audio  
3 Gain Ctl 6 +LV Source



Other A.R.C. Equipment

RT-524() VHF Transceiver \*27

|                   |                  |                    |
|-------------------|------------------|--------------------|
| J-3-( ) Power and | Audio *22,28     |                    |
| A Gnd             | H Speaker Out    | P +LV IN (Unsw'd)  |
| B n/c             | J Aux Audio 2 In | R RT-524 Audio In  |
| C Phone Out       | K +LV Out (Sw'd) | S Amp +LV In       |
| D Aux Audio 1 In  | L Spkr Sidetone  | T Aux Audio 4 In   |
| E Panel Lights    | M Mic Key        | U +LV In To Switch |
| F n/c             | N Aux Audio 3 In | V Mic Input        |

R-836/ARN-59 ADF Rec

|                           |                |       |
|---------------------------|----------------|-------|
| J-101 (12426) To Loop Ant |                |       |
| A Loop Input 1            | B Loop Input 2 | C Gnd |

J-103 (12357) Power & Ctl

|                  |                  |                 |
|------------------|------------------|-----------------|
| A +LV In         | H Band III Sel   | O AF Plate Out  |
| B +HV2 In (125v) | I 13v, 100~0° in | P n/c           |
| C +HV1 In (110v) | J Tel            | Q Loop Position |
| D Modulator Ctl  | K Sens           | R Loop Relay    |
| E AF Grid In     | L BFO Ctl        | S Gnd           |
| F Band I Sel     | M ± Plate        |                 |
| G Band II Sel    | N ̄ Plate        |                 |

C-2275/Arn-59 Ctl Box for R-836

|                            |                   |                     |
|----------------------------|-------------------|---------------------|
| J-201 (12357) To Equipment |                   |                     |
| A n/c                      | H Band I Sel      | O Gain Ctl (AF Pl.) |
| B Phase 2 Ctl              | I BFO Ctl         | P Sens              |
| C Band Sel Gnd             | J Panel Lights    | Q Power Ctl         |
| D n/c                      | K Loop Position   | R Modulator Ctl     |
| E Gain (AF Grid)           | L 13v, 100~0/180° | S Gnd               |
| F Band III Sel             | M 13v, 100~180/0° | *29                 |
| G Band II Sel              | N Loop Relay Ctl  |                     |

## Notes







- 1 Only used on .19-.55 & .52-1.5 MHz Rec's
- 2 If no transmitter is used, jumper pins A & E with wired plug ARC# 11934
- 3 T-15,-16,-17 Only
- 4 Rec Audio plus Trans Sidetone
- 5 Pins G & H not used in any installation drawings found
- 6 J-6,-7 (J-601,-602) are identical & either may go to the modulator. The other is for connecting multiple rec. racks together as one system.
- 7 AVC Ctl when VHF rec (R-28) is installed.
- 8 Not on R-28
- 9 On R-28 Only
- 10 On T-23 Only
- 11 Both the same. Allows 2 LF/MF transmitters to connect to 1 antenna tuner
- 12 On early control boxes only
- 13 Pins 1 & 6 jumpered in control box
- 14 Also has JK-48 on a cord and mic & phone jacks
- 15 Tran 2 only has 4 channels. Position 5 for tran 2 goes to pin F rather than pin E.
- 16 Proper ident for connector not available yet.
- 17 Position 16 selects Tran 3 with no crystal for ICS use.
- 18 On J-22,-22() only
- 19 All connectors the same and are interchangeable.
- 20 No Test Set-ups are included.
- 21 MX-2/ARR-2 Wired Plug is required in Ctl Box recept on rack. This jumpers pins 1 & 6, and 2 & 8 together to allow the receiver to work from the control box attached to it.
- 22 Not an A.R.C.-type connector
- 23 Key notch over pin B
- 24 Key notch over pin I
- 25 Connector similar to ARC# 5488
- 26 Not on R-13
- 27 'A' suffix freq range is 118.00-135.95 MHz.  
'M' suffix freq range is 136.00-149.95 MHz.  
Pinout shown is from 'A' equipment and is assumed to be the same as 'M' equipment.
- 28 Aux and RT-524 Audio inputs are to internal mixer/amp, which may be used independantly of the rest of the radio.
- 29 Pins L & M are switched for different antenna mounts. The first angle is for belly-mounted antennas and the second is for top-mounted antennas.



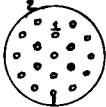



## CONNECTOR LISTS



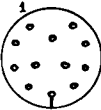

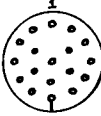
All Command series and Type 12 recepticals are shown on the following pages in numeric order. Some extra A.R.C. connectors are shown as well where I have information on them. The recepticals are shown as viewed from the outside. Pin 1 or A is indicated on the drawings, and the pin identification proceeds from there anti-clockwise. It should be noted that in many if not all cases, the pins are marked on the wired side of the connectors.

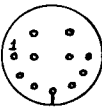

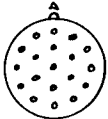

Some crossing between Command and Type 12 connectors is possible as shown in the notes. (Notes are indicated as in the previous section.) For the most part, Command set connectors are un-keyed, while the later Type 12, etc ones do have keying ridges. The keying can be defeated (Files are handy for this.) to allow the later type plugs to be used un the Command set recepticals, as well as in ones with the same pin arrangement but different keying.

There are other A.R.C. connectors however these aren't shown due to lack of information on them.

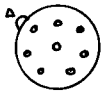
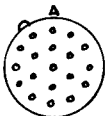
| Receipt Ident | No Pins | Front View  | Mating Cable                   | Plugs Open Wire | Used On  |
|---------------|---------|---|--------------------------------|-----------------|--|
| 2674          | 2       |    | 3146<br>PL-157                 |                 | C-42,-43, ARC-5 Trans Racks<br>Early BC-451's                            |
| 5571          | 18      |    | 6962                           | 9585            | C-29,-30, ARC-5 Modulator  |
| 5577<br>*1    | 6       |    | 6784<br>PL-151                 | 9123<br>PL-151A | J-28, R-28, All Rec Racks,<br>All Modulators                             |
| 5842<br>*2    | 7       |    | 5488 (on rear<br>of Equipment) |                 | All Rec Racks, SCR-274N &<br>ATA Trans Racks                             |
| 6418<br>*3    | 8       |    | 6577<br>PL-152                 | 9125<br>PL-152A | C-2,-26,-42,-43,-125,-744,<br>SCR-274N & ARA Rec Ctl Boxes,<br>R-4, T-23 |
| 6485          | 2       |   | 6578<br>PL-147                 | 9127<br>PL-147A | All Rec Racks  |
| 7023          | 5       |  | 6967<br>PL-156                 | 9124<br>PL-156A | All Trans Racks & Ant Relays   |
| 7024          | 3       |  | 6965<br>PL-148                 | 9126<br>PL-148A | J-17, All Modulators   |

| Receipt Ident | No Pins | Front View  | Mating Cable                     | Plugs Open Wire | Used On   |
|---------------|---------|---|----------------------------------|-----------------|---|
| 7025          | 12      |    | 6964<br>PL-154                   | 9122<br>PL-154A | C-30,-39,-48, J-17,-28,<br>SCR-274N & ATA Modulators<br>& Trans Racks |
| 7026          | 8       |    | 6966                             | 9121            | J-17,-28, T-23, MD-7  |
| 7027          | 18      |    | 6963<br>PL-153                   | 9121<br>PL-153A | C-38, J-17, SCR-274N & ATA<br>Modulators & Trans Ctl Boxes            |
| 9296          | 7       |    | 9302 (On rear<br>of ARC-5 Trans) |                 | ARC-5 Trans Racks   |
| 9336          | 3       |    | -- 9488 --                       |                 | C-39,-48, J-16,-22, MX-19   |
| 9417          | 12      |   | 9377                             | 9589            | J-34, MD-7,<br>ARC-5 Trans Racks                                      |
| 9835          | 2       |  | -- 9818 --                       |                 | C-27  |
| 9849          | 3       |  | -- 9848 --                       |                 | TN-6, T-15,-16,-17  |

| Receipt Ident | No Pins | Front View  | Mating Cable                 | Plugs Open Wire | Used On  |
|---------------|---------|---|------------------------------|-----------------|--|
| 11905<br>*1   | 6       |    | 12151                        | 14051           | C-16,-17, R-13,-20,-34,<br>Type 12 Rec & Trans                               |
| 12093         | 4       |    | 12372<br>12375               | 14052           | C-24,-39,-56, Type 12 Trans  |
| 12095<br>*2   | 7       |    | (On rear<br>Of Rack-mt Eq't) | ARN-30          | (Type 15) Equipment<br>Racks   |
| 12096<br>*4   | 19      |    | 12139                        | 14320           | C-24,-25,-36,-37,-38,-39,<br>C-40,-56  |
| 12097<br>*3   | 8       |    | 12098                        | 14050           | C-36,-37,-37,-40,-48,<br>C-3436/ARN-30D, Type 12 Trans,<br>Type 15 Eq't Rack |
| 12348<br>*3   | 8       |   |                              |                 | Type 15 Eq't Rack  |
| 12355<br>*3   | 8       |  |                              |                 | C-3436/ARN-30D   |
| 12357<br>*4   | 19      |  |                              |                 | C-2275 & R-836/ARN-59<br>C-3436 & R-1021/ARN-30D<br>Type 15 R-34             |

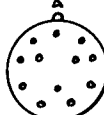
| Receipt<br>Ident | No<br>Pins | Front<br>View   | Mating<br>Cable | Plugs<br>Open<br>Wire | Used On                      |
|------------------|------------|---|-----------------|-----------------------|------------------------------|
| 12426            | 3          |  |                 |                       | R-836/ARN-59                 |
| 12427            | 2          |  | 14321           |                       | Type 12 Rec's, Type 15 Racks |
| 12               |            |  |                 |                       | TV-10 (CV-431/AR)            |
| 12               |            |  |                 |                       | TV-10 (CV-431/AR)            |
| 12               |            |  |                 |                       | R-22                         |

NOTES

- 1 Plugs for recepticals 5577 and 11905 may be used interchangeably if the keying is defeated on the newer plugs.
- 2 A.R.C. Type 15 receivers may be used in Command set receiver racks and vice-versa if wiring changes are made to accommodate the different pinouts.
- 3 Plugs for recepticals 6418, 12097, 12348, and 12355 may be used interchangeably if the keying is defeated on the newer plugs.
- 4 Plugs for recepticals 12096 and 12357 may be used interchangeably if the keying is defeated. Some caution should be exercised since without the keys there are several ways to insert the plugs into the recepticals.

SCR-274N to A.R.C. Plug Cross Reference

| SCR-274N<br>Ident | A.R.C.<br>Ident |
|-------------------|-----------------|
| PL-147            | 6578            |
| PL-147A           | 9127            |
| PL-148            | 6965            |
| PL-148A           | 9126            |
| PL-151            | 6784            |
| PL-151A           | 9123            |
| PL-152            | 6577            |
| PL-152A           | 9125            |
| PL-153            | 6963            |
| PL-153A           | 9121            |
| PL-154            | 6964            |
| PL-154A           | 9122            |
| PL-156            | 6967            |
| PL-156A           | 9124            |
| PL-157            | 3146            |



## NUMERIC ORDER LISTS

The following lists are divided into two groups. The first is a set of "in type" lists for the various series from the first sections of this booklet. The second is a list of all the units previously mentioned for which A.R.C. part numbers were found, and is in numeric order by that number.

Note that some items not in the equipment lists are listed here. these are 'uncommon units (such as the VHF SCR-274N units) or detail pieces (like connector caps.) These lists are therefore more complete than the previous ones and are useful as 'check lists' for these items.

An astrisk used as a suffix to a unit's identifier indicates that there are or may be trailing letters and that all versions are being refered to. For example: C-30\* refers to both the C-30 and the C-30A.

SCR-274N

BC-442 Antenna Relay  
BC-450 Ctl Box, 3 Rec  
BC-451 Ctl Box, Trans  
BC-453 Rec, .19-.55 mHz  
BC-454 Rec, 3.0-6.0 mHz  
BC-455 Rec, 6.0-9.1 mHz  
BC-456 Modulator  
BC-457 Trans, 4.0-5.3 mHz  
BC-458 Trans, 5.3-7.0 mHz  
BC-459 Trans, 7.0-9.1 mHz  
BC-473 Ctl Box, 1 Rec  
BC-496 Ctl Box, 2 Rec  
BC-696 Trans, 3.0-4.0 mHz  
BC-938 Ctl Box, HF & VHF Trans  
BC-942 Rec, 100-156 mHz  
BC-946 Rec, .52-1.5 mHz  
BC-950 Trans, 100-156 mHz  
DM-32 Dynamotor, Rec  
DM-33 Dynamotor, Trans  
FT-220 Rack, 3 Rec  
FT-221 Mount, 3 Rec  
FT-222 Mount, 3 Rec Ctl Box  
FT-225 Mount, Modulator  
FT-226 Rack, 2 Trans  
FT-227 Mount, 2 Trans  
FT-228 Mount, Trans Ctl Box  
FT-229 Mount, Antenna Relay  
FT-230 Adaptor, Remote Ctl  
FT-231 Mount, 1 Rec  
FT-232 Mount, 1 Trans  
FT-233 Rack, 1 Rec  
FT-234 Rack, 1 Trans  
FT-235 Mount, 1 Rec Ctl Box  
FT-240 Mount, 2 Rec Ctl Box  
FT-260 Adaptor, Local Ctl  
FT-262 Mount, 3 Trans  
FT-264 Rack, 4 Rec  
FT-276 Rack, 3 Trans  
FT-277 Rack, 2 Rec  
FT-278 Mount, 4 Rec  
FT-279 Mount, 2 Rec  
FT-310 Adaptor, Power  
FT-331 Rack, 4 Trans  
FT-332 Mount, 4 Trans  
I-84A Meter Unit, Rec Test  
I-85A Meter Unit, Trans Test  
MC-211 Adaptor, Rt Angle Drive  
MC-212 Dial, 6.0-9.1 mHz  
MC-213 Dial, 3.0-6.0 mHz  
MC-214 Dial, .19-.55 mHz  
MC-215 Kit, Tuning Shaft  
MC-415 Dial, .52-1.5 mHz  
PL-192 Wired Plug  
RC-54A Test Set-up, Rec  
RC-55A Test Set-up, Trans

NAVY

21531 Dynamotor, Rec  
21626 Dynamotor, Trans  
23155 Ctl Box, 2 Rec  
23243 Ctl Box, Trans  
23251 Ctl Box, 3 Rec  
23261 Ctl Box, 1 Rec  
29125 Antenna Relay  
29126 Mount, Antenna Relay  
46085 Mount, 2 Rec  
46104 Rec, 1.5-3.0 mHz  
46105 Rec, 3.0-6.0 mHz  
46106 Rec, 6.0-9.1 mHz  
46110 Rack, 2 Rec  
46129 Rec, .19-.55 mHz  
46145 Rec, .52-1.5 mHz  
46149 Rack, 3 Rec  
46150 Mount, 3 Rec  
49107 Adaptor, Remote Ctl  
50083 Modulator, ATA  
50084 Mount, Modulator  
50141 Modulator, ARC-5  
52208 Trans, ATA, 3.0-4.0 mHz  
52209 Trans, ATA, 4.0-5.3 mHz  
52210 Trans, ATA, 5.3-7.0 mHz  
52211 Trans, ATA, 7.0-9.1 mHz  
52212 Rack, 2 Trans  
52213 Mount, 2 Trans  
52232 Trans, ATA, 2.1-3.0 mHz  
52302 Trans, ARC-5, .50-.80 mHz  
52303 Trans, ARC-5, .80-1.3 mHz  
52304 Trans, ARC-5, 1.3-2.1 mHz  
52305 Trans, ARC-5, 2.1-3.0 mHz  
52306 Trans, ARC-5, 3.0-4.0 mHz  
52307 Trans, ARC-5, 4.0-5.3 mHz  
52308 Trans, ARC-5, 5.3-7.0 mHz  
52309 Trans, ARC-5, 7.0-9.1 mHz  
62036 Adaptor, Power

ARC-5

|       |                              |        |                          |
|-------|------------------------------|--------|--------------------------|
| C-24  | Adaptor, Local Ctl           | MT-69  | Rack, 1 Trans            |
| C-25  | Ctl, Rem Ant/Loop Sw         | MT-70  | Mount, 2 Trans           |
| C-26  | Ctl Box, 1 Rec, Tuneable     | MT-71  | Rack, 2 Trans            |
| C-27  | Ctl Box, 1 Rec, Lock-tuned   | MT-72  | Mount, 3 Trans           |
| C-29  | Ctl Box, HF Trans            | MT-73  | Rack, 3 Trans            |
| C-30* | Ctl Box, HF Trans & VHF Chan | MT-74  | Mount, 4 Trans           |
| C-38  | Ctl Box, Main                | MT-75  | Rack, 4 Trans            |
| C-39  | Ctl Box, Auxiliary           | MT-76  | Mount, Modulator         |
| C-42  | Ctl Box, 1 Rec, VHF          | MT-77  | Mount, Antenna Relay     |
| C-43  | Ctl Box, 3 Rec, HF & VHF     | MT-78  | Mount, Ctl & Jack Box    |
| C-48  | Ctl Box, Auxiliary           | MT-80  | Mount, Ctl & Junct Box   |
| C-125 | Ctl Box, 1 Rec, Tuneable     | MT-84  | Mount, Junct Box         |
| C-131 | Ctl Head, 6 Chan, HF Rec     | MT-98  | Mount, Ctl Box           |
| C-744 | Ctl Box, 1 Rec, Tuneable     | MT-159 | Mount, Antenna Tuner     |
| DY-1  | Dynamotor, Rec, 12v          | MT-411 | Rack, 1 Rec, 12v         |
| DY-2* | Dynamotor, Rec               | MX-19  | Adaptor, Audio           |
| DY-8  | Dynamotor, Trans             | MX-20  | Adaptor, Power           |
| ID-25 | Dial, .19-.55 mHz            | MX-21  | Adaptor, Remote Ctl      |
| ID-26 | Dial, .52-1.5 mHz            | MX-22  | Adaptor, Rt Angle Drive  |
| ID-27 | Dial, 1.5-3.0 mHz            | O-4A   | Osc, Lock-tuned Rec Tune |
| ID-28 | Dial, 3.0-6.0 mHz            | R-23*  | Rec, .19-.55 mHz         |
| ID-29 | Dial, 6.0-9.1 mHz            | R-24   | Rec, .52-1.5 mHz         |
| J-16  | Jack Box, Mic/Tel            | R-25   | Rec, 1.5-3.0 mHz         |
| J-17* | Junction Box, System         | R-26   | Rec, 3.0-6.0 mHz         |
| J-22* | Jack Box, Mic/Tel            | R-27   | Rec, 6.0-9.1 mHz         |
| J-28  | Junct Box, VHF Chan Split    | R-28   | Rec, 100-156 mHz         |
| J-33  | Wired Plug                   | R-148  | Rec, .19-.55 mHz         |
| J-34  | Junct Box, Trans Ctl         | RE-2   | Antenna Relay            |
| MD-7  | Modulator                    | T-15   | Trans, .50-.80 mHz       |
| MT-4  | Mount, Ctl Box               | T-16   | Trans, .80-1.3 mHz       |
| MT-5  | Mount, 1 Rec                 | T-17   | Trans, 1.3-2.1 mHz       |
| MT-7A | Rack, 1 Rec                  | T-18   | Trans, 2.1-3.0 mHz       |
| MT-62 | Mount, 2 Rec                 | T-19   | Trans, 3.0-4.0 mHz       |
| MT-63 | Rack, 2 Rec                  | T-20   | Trans, 4.0-5.3 mHz       |
| MT-64 | Mount, 3 Rec                 | T-21   | Trans, 5.3-7.0 mHz       |
| MT-65 | Rack, 3 Rec                  | T-22   | Trans, 7.0-9.1 mHz       |
| MT-66 | Mount, 4 Rec                 | T-23   | Trans, 100-156 mHz       |
| MT-67 | Rack, 4 Rec                  | TN-6   | Antenna Tuner            |
| MT-68 | Mount, 1 Trans               |        |                          |

## A.R.C. Equipment

|       |                               |       |                             |
|-------|-------------------------------|-------|-----------------------------|
| A-12  | Antenna, VHF                  | J-12  | Junction Box, 32 pos, 12v   |
| B-13  | Converter, VOR/IIS            | J-13  | Junction Box, 32 pos, 24v   |
| C-16  | Ctl Box, R-11 Rec             | J-15  | Junction Box, 56 pos, 24v   |
| C-17  | Ctl Box, R-15 Rec             | L-10  | Antenna, Loop               |
| C-18  | Ctl Box, Loop Heading         | M-11  | Mount, 1 Rec                |
| C-24  | Ctl Box, 3 Rec, 2 Trans, Loop | M-12  | Mount, 1 Trans              |
| C-25  | Ctl Box, 3 Trans              | M-13  | Mount, Ctl Box              |
| C-26  | Ctl Box, R-10 Rec             | M-18  | Mount, Ctl Box              |
| C-36  | Ctl Box, 2 Rec, 3 Trans, Loop | M-19  | Mount, Ctl Box              |
| C-37  | Ctl Box, 2 Rec, 3 Trans       | P-10  | Power Supply, Trans Test    |
| C-38  | Ctl Box, 2 Rec, 3 Trans       | P-11  | Power Supply                |
| C-39  | Ctl Box, 2 Rec, 2 Trans, Loop | R-10* | Rec, .52-1.5 mHz            |
| C-40  | Ctl Box, 3 Rec, 3 Trans       | R-11* | Rec, .19-.55 mHz            |
| C-48  | Ctl Box, R-11 Rec, Loop       | R-13  | Rec, 108-136 mHz, Type 15   |
| C-56  | Ctl Box, R-19 Rec, 4 Trans    | R-15  | Rec, 108-136 mHz            |
| C-81  | Ctl Box, R-34 Rec             | R-19  | Rec, 118-148 mHz            |
| C-88  | Ctl Box, R-34 Rec             | R-20  | Rec, 75 mHz, Fixed-tuned    |
| D-10* | Dynamotor                     | R-22  | Rec, .52-1.5 mHz            |
| DV-10 | Dynavertter Power Supply      | R-34  | Rec, 108-126.9 mHz, Type 15 |
| E-14  | Rack, Type 15 Rec & Conv      | T-11* | Trans, 118-132 mHz          |
| H-19  | Test Set, Rec & Trans         | T-13* | Trans, 132-148 mHz          |
| J-10  | Jack Box, Mic/Tel             |       |                             |

### A.R.C. Part Numbers

1943 Cover, For Receipt 2226  
2226 Recept, Power Adaptor  
2674 Recept, 2-pin, 7/8"  
3146 Plug, 2-pin, PL-157  
5005 Receiver, -46104  
5006 Receiver, -46105  
5007 Receiver, -46106  
5009 Transmitter, -52208  
5010 Transmitter, -52209  
5011 Transmitter, -52210  
5012 Transmitter, -52211  
5013 Modulator, -50083  
5014 Control Box, BC-450,-23251  
5017 Ant. Relay, BC-442,-29125, RE-2  
5018 Rack, FT-277,-46110, MT-63  
5019 Rack, FT-264, MT-67  
5020 Rack, FT-226,-52212  
5168 Dynamotor, DM-33,-21626, DY-8  
5319 Cover, 1-1/8" Recept  
5488 Plug, 7-pin, On Rack-mt eq't  
5571 Recept, 18-pin, 1-5/8"  
5577 Recept, 6-pin, 1-1/8"  
5694 Mount, FT-278,-46085, MT-62  
5842 Recept, 7-pin, For Rack-mt eq't  
5950 Receiver, -46145  
  
6051 Dial, MC-214, ID-25  
6052 Dial, MC-415, ID-26  
6053 Dial, MC-213, ID-28  
6054 Dial, MC-212, ID-29  
6090 Rack, FT-331  
6151 Tuning Shaft Kit, MC-215  
6357 Rt-angle Adaptor, MC-211, MX-22  
6418 Recept, 8-pin, 1-1/8"  
6433 Adaptor, FT-230,-49107, MX-21  
6434 Adaptor, FT-260, C-24  
6485 Recept, 2-pin, 1-1/8"  
6546 Control Box, BC-496,-23155  
6577 Plug, 8-pin, Cable, PL-152  
6578 Plug, 2-pin, Cable, PL-147  
6743 Knob, MC-236, MC-237  
6767 Wired Plug, PL-192, J-33  
6784 Plug, 6-pin, Cable, PL-151  
6831 Mount, FT-240  
6962 Plug, 18-pin, Cable  
6963 Plug, 18-pin, Cable, PL-153  
6964 Plug, 12-pin, Cable, PL-154  
6965 Plug, 3-pin, Cable, PL-148  
6966 Plug, 8-pin, Cable  
6967 Plug, 5-pin, Cable, PL-156  
  
7023 Recept, 5-pin, 1-1/8"  
7024 Recept, 3-pin, 1-1/8"  
7025 Recept, 12-pin, 1-5/8"  
7026 Recept, 8-pin, 1-1/8"  
7027 Recept, 18-pin, 1-5/8"  
7043 Control Box, BC-473,-23261  
7053 Mount, FT-235, MT-4  
7054 Mount, FT-222, MT-98  
7056 Mount, FT-229,-29126  
7057 Mount, MT-159  
7058 Mount, FT-225,-50084  
7059 Mount, FT-231, MT-5  
7060 Mount, FT-221,-46150, MT-64  
7061 Mount, FT-232, MT-68  
7062 Mount, FT-227,-52213, MT-70  
7063 Mount, FT-262, MT-72  
7064 Mount, FT-332, MT-74  
7065 Mount, MT-77  
7067 Mount, MT-76  
7083 Mount, FT-228, MT-80  
7095 Control Box, BC-451,-23243  
7314 Control Box, C-29  
7369 Rec Test Panel, I-84A  
7491 Knob  
7507 Rack, FT-234  
7509 Rack, FT-233, MT-7A  
7535 Dial, ID-27  
7537 Rack, FT-220,-46149, MT-65  
7544 Trans Test Panel, I-85A  
7591 Modulator, BC-456  
7594 Receiver, BC-453  
7595 Receiver, BC-454  
7596 Receiver, BC-455  
7632 Transmitter, BC-457  
7633 Transmitter, BC-458  
7634 Transmitter, BC-459  
7638 Rack, FT-276  
7777 Dummy Antenna, A-61A  
7839 Receiver, -46129  
7916 Transmitter, -52232  
7918 Rec Test Set-up, RC-54A  
7919 Trans Test Set-up, RC-55A

A.R.C. Part Numbers, Con't

9074 Adaptor, FT-310,-62036,MX-20  
9121 Plug,18-pin,Open-wire,PL-153A  
9122 Plug,12-pin,Open-wire,PL-154A  
9123 Plug,6-pin,Open-wire,PL-151A  
9124 Plug,5-pin,Open-wire,PL-156A  
9125 Plug,8-pin,Open-wire,PL-152A  
9126 Plug,3-pin,Open-wire,PL-148A  
9127 Plug,2-pin,Open-wire,PL-147A  
9202 Rack, MT-411  
9296 Recept, 7-pin,For ARC-5 Trans  
9302 Plug, 7-pin, On ARC-5 Trans  
9306 Rack, MT-69  
9307 Rack, MT-71  
9308 Transmitter, T-18  
9309 Transmitter, T-19  
9310 Transmitter, T-20  
9311 Transmitter, T-21  
9312 Transmitter, T-22  
9313 Modulator, MD-7  
9315 Transmitter, T-15  
9316 Transmitter, T-16  
9317 Transmitter, T-17  
9336 Recept,3-pin,7/8",key-up  
9369 Oscillator, 0-4A  
9375 Cover, 7/8" Recept  
9377 Plug, 12-pin, Cable  
9417 Recept, 12-pin, 1-5/8"  
9451 Mount, MT-78  
9488 Plug, 3-pin, Key up  
9554 Knob/cap  
9556 Trans Test Panel  
9558 Trans Test Set-up  
9562 Junction Box, J-34  
9584 Plug, 12-pin, Open-wire  
9585 Plug, 18-pin, Open-wire  
9593 Rack, MT-73  
9594 Rack, MT-75  
9595 Adaptor, MX-19  
9601 Control Box, C-26  
9602 Receiver, R-23  
9603 Receiver, R-24  
9604 Receiver, R-25  
9605 Receiver, R-26  
9606 Receiver, R-27  
9607 Antenna Tuner, TN-6  
9609 Junction Box, J-28  
9610 Control Box, C-38  
9808 Cover, Ant/Loop Sw Ctl  
9818 Plug, 2-pin, Key lt  
9821 Plug, 8-pin, Open-wire  
9835 Recept, 2-pin, 7/8", Key lt  
9848 Plug, 3-pin, Key left  
9849 Recept, 3-pin, 7/8", Key lt  
9850 Control Box, C-27  
9867 Jack Box, J-22  
9901 Control Box, C-39  
9902 Control Box, C-48  
9903 Junction Box, J-17\*  
9904 Mount, MT-84  
9905 Jack Box, J-16  
9907 Jack Box, J-22A,B  
9910 Control Box, C-30A  
9911 Control Box, C-125  
10007 Receiver, R-23A  
10008 Receiver, R-148  
10009 Dynamotor, DY-2B  
11905 Recept,6-pin,1-1/8",Key up  
11934 Wired Plug  
12093 Recept, 4-pin, 7/8",Key up  
12095 Recept, 7-pin,For Rack-mt,eqt  
12096 Recept,19-pin,1-5/8",Key up  
12097 Recept,8-pin,1-1/8",Key up  
12098 Plug,8-pin,Cable,Key up  
12125 Plug,6-pin,Cable,Key up  
12139 Plug,19-pin,Cable,Key up  
12296 Wire Antenna Kit  
12348 Recept,8-pin,1-1/8",Key rt  
12355 Recept,8-pin,1-1/8",Key lt  
12357 Recept,19-pin,1-5/8",Key lt  
12372 Plug,4-pin,Cable,Key up  
12375 Plug,4-pin,Cable,Key up  
12426 Recept,3-pin,7/8",Key up  
12427 Recept,2-pin,7/8",Key up  
14050 Plug,8-pin,Open-wire,Key up  
14051 Plug,6-pin,Open-wire,Key up  
14052 Plug,4-pin,Open-wire,Key up  
14320 Plug,19-pin,Open-wire,Key up  
14321 Plug,2-pin,Open-wire,Key up  
14480 Dynamotor, D-10A(12v)  
14482 Dynamotor, D-10A(24v)  
14588 Cover, 1-1/8" Recept  
14589 Cover, 7/8" Recept  
15392 Capacity Plate for T-13  
15900 Capacity Plate for T-13A

## QUICK & DIRTY CONNECTIONS

There has been in the past three decades, a virtual plethora of articles on the conversion of the Command (and later, the Type 12 et al) radios. These have, over that span, covered every reasonable (and I suppose an occasional unreasonable) use that these units might have. However these sources are no longer available which leaves the current user with a minor disadvantage. In order to at least partially fill the information gap, following are a few simple hook-ups (not really conversions in the strict sense of the term) which will get the radios working with a minimum of fuss and bother. A couple of wiring diagrams are shown at the end to aid where the descriptions are lacking in clarity. The over-all result is essentially a starting point from which you may launch your own ideas.

Except for the Command transmitters and the R-836/ARN-59, the units all will run from a power supply good for 24v at 1.5 to 2 amps and around 250v at 80-100 ma. To use the transmitters and transmitter, the low voltage should be rectified and well filtered, although there's no reason this can't be done only where it's necessary.

Probably the best supply for these units is the one Fair Radio has. This is not only a power supply, but also has a speaker, phone jack, gain control and BFO switch (which can be used for other things as we'll see later.) The cabinetry is nice and there is enough room inside for extra goodies should they be desirable.

Another route is to get a dynamotor and remove everything from the base except the plug and snap-slides. A very neat power supply can now be built on the base so the whole shebang fits in the old dynamotor space. The Fair #818 transformer was designed to run the Command sets and is perfect for this.

Now that we've got power, let's see what happens.....

### Command Receivers

These are among the easiest receivers in the surplus market to get running. If the dynamotor-mount power supply is used, BFO and gain controls plus a phone jack must be added. These can be brought out the front from the adaptor well connector (Don't forget to keep pins 6 & 7 jumpered or the tubes don't get nice and warm!) although an extra wire for the receiver audio will have to be pulled to an unused pin. Alternatively they can be brought out the rear connector without any changes. The gain control is a simple 50k-ohm pot to ground and the BFO control is a SPST switch to ground with the closed position being 'OFF'.

While a phone jack is still needed (and easily added), capturing a C-24 or FT-260 local control adaptor makes all this bunches easier. If one isn't handy, a little careful layout can be used

to make one from a remote control adaptor. By squeezing a bit and careful parts selection, a phone jack can be added thus going A.R.C. one better!

If a local tuning knob isn't available, a radio-tv push-on knob, a piece of tubing pressed over the spline, or whatever else you can find that will turn the shaft is just fine for tuning. If you can get a piece of shaft with one good end (or just the ends from a shaft kit) then a knob can be fitted to the end of the inner piece and locked in place like the local knob is. The bottom line is 'Use whatever works for you.'

One note- All the sets I've had were wired for 600 ohms, however some of the early units had a high-impedance tap as well. It may be wise to check your radio to see how it's wired if you have one of them.

The LF (.19-.55 mHz) receivers make nice add-on units for receivers having an IF in that range and are suffering from a lack of sensitivity. Simply wrap a piece of insulated wire around the input lead to the grid of the first IF stage and connect the other end to the antenna post of the LF receiver. Tune the LF receiver to the IF of the other, fire up both and listen on the audio output of the add-on. The selectivity can be sharpened by removing the covers from the IF cans on the LF unit and pulling the fiber rods up. Don't get too 'dedicated' to this process though- there is a stop and the rods do break! The selectivity can be set by adjusting the rods to suit your needs, although all the way up is beautiful for CW. This operation is known as a 'Q-5er' and has been around for quite a while. But, old as the process is, it still works very nicely.

### Type 12 Receivers

These are about the same to convert as the Command sets with the only complication being the lack of a dial. This has been covered by Fair very nicely in the form of a BC-473 control box fitted with an adaptor to mount on the front of the receivers. This has the advantage that a gain control plus a switch that can be used for the Audio Hi-Lo control on the VHF units are already on the box.

To use the rear-mounted power supply, pins A & E of the top connector have to be tied together to get B+ from the power supply to the receiver. The BC-473 controls can be used by connecting the lower right-hand receptacle to the one on the box- pin A to 2, C to 4, and E to 3. By connecting pin B to 7 and putting a 1000 ohm resistor from pin 7 to ground in the box or pin B to ground in the receiver (leaving the other wiring on the pin used intact) the Audio Hi-Lo circuit will work. Otherwise, pin B must be grounded. Hi audio will be with the BFO control in 'MCW'. A little paint, patience and a signal source will handle the dial re-calibration although for the R-11 it's not necessary.



To use the Fair unit, remove the wire from pin F of the lower right connector and move the wire from pin E of the upper one down to the pin just emptied. This puts the receiver B+ on the lower connector and allows it to be used for everything. Using the pin-out for this connector (remembering the change just suggested) and the one for the rear of a Command receiver, the cable from the power/control unit can be modified to work with these receivers. The Audio Hi-Lo line will still need the 1000 ohm resistor.

The R-11 can be used as a Q-5er however the main receiver's BFO will have to be used since the Type 12's don't have one. Alternatively, one could be installed using the parts and circuit from a Command receiver or a semiconductor circuit could be added to handle this. Some squeezing may be necessary, but use your imagination.

### Other Receivers

Using the R-13 is sort of a cross between the Command boxes and the Type 12's. To get power and control to it, the rear connector has to be used, however the tuning is like the Type 12's. While either power supply mentioned before can be used, the Fair unit is more practical since the other requires set modification to get the controls and audio output in. There is room on the front for the pot and jack so if this is what you want there's no problem there. Note that if the R-445 is being used, pins A & E of the front connector have to be jumpered to get B+ to the receiver if the rear-mounted power supply is being used.

The R-20 is easy... it's fixed tuned at 75 MHz and, unless one likes listening for marker beacons, requires some pretty big modifications to use. This is a good one to play with since there is potential in it to be something else, although the only thing that comes to mind is a monitor for some favored frequency like on 6 meters which isn't that too awful far away.

The R-22 likewise is easy, but for a different reason. This set is much like the R-10 but with only one instead of three recepticals. By following the pinouts, everything mentioned on the Type 12 sets applies to this one as well.

A real challenge is presented by the R-34. This unit uses a motor driven crystal select system to tune to the desired frequency. (It also requires that the low voltage be dc and not ac.) Since, to select the proper frequency, it uses 10 wires in a non-redundent code (five each for MHz and tenth MHz) the original control box is necessary. There are three squelch options- none (pin F of either front connector grounded), internal (jumper between pin E and pin F of the big receptical, J-2) or external (a 100k ohm pot to ground from pin F of either receptical.) Gain and audio are handled as in the Type 12 receivers.

One of the newer A.R.C. receivers to hit the market is the R-836/ARN-59. This is a modernized ARN-6 or LM-26 and is smaller and lighter than either of those anchors. Power is easy- +24v at

about 1-1½ amps and +110 & +125v for B+. The latter may, without any major detriment, be tied to the +110v line thus simplifying the power supply. The volume control is a 100k ohm pot with one end grounded, the other tied to the AF Plate lead, and the tap to the AF Grid line. The RF sens control is a 50k ohm pot to ground, or the line may be grounded directly. Like the Command sets, the BFO control is grounded to turn the BFO off. Band selection is by grounding the proper pin. For just listening, pins D, I, M, N, O, Q, & R may be ignored.

The original control box is suggested for this unit not only for the controls but for the three-band dial. A little ingenuity and some tin-bending can be used to make a false front for the receiver to mount the control box as well as the phone jack, thus making a neat, compact unit.

### Command Transmitters

Like the Command receivers, these are very easy to get working in their original form, and accept modification very nicely. They make neat little single-band rigs that will load practically anything with a short wire (up to 50') being their 'specialty'.

The power needed is 24v at about 1½ amps (filtered dc if the relays are to be used), around +200v at about 10ma of stiffly regulated dc for the oscillator B+, 250v at around 15ma for the P.A. screens and up to 600v at up to about 200ma for the P.A. B+.

Keying the 'Select' line will result in full break-in operation since the Select relays connect the oscillator to its B+, ground the P.A. cathodes, and attach the output to the antenna. This gets noisy for a home environment, although in a prop-driven bomber, no one seemed to notice. Tying the osc. B+ directly to the oscillator, and the cathodes to a key jack will result in a quieter operation, although break-in is no longer possible. An rf choke should be put between the cathodes and the jack, and bypass caps (.01 to .001uf at 1kv) on both ends of the choke. There's very few 'bad habits' in these rigs (click, chirp, etc) and those that are present may be cleaned up by normal techniques.

Tune-up is simple. Tune to the desired frequency, apply high voltage, and tune the loading & coupling controls for maximum output. An antenna relay's handy here- the output meter's on it.

The 4-5.3 MHz transmitters will go down to 80 meters by closing the cap under the cover between the P.A. tubes and the rest. Likewise the 5.3-7 MHz boxes will go to 40 meters by opening the cap, or by lopping a few turns off the oscillator coil, as you may wish.

In both cases, the dial will have to be recalibrated and the P.A. 'fixed' cap will have to be re-adjusted for maximum output. The tracking won't be as good, but over short segments (like the Novice sub-bands) it's close enough that re-trimming isn't needed. A short extension and knob can be put on the cap's shaft to juggle it if you like, but if the initial tune-up is in the center of the band, then it shouldn't be needed for narrow segments.

In the cathode keyed version, there's a slight drift in the oscillator. Typically, mine have slipped down about 100 cycles in around 10-20 minutes then stayed put. I haven't tried relay keying however it may be more stable since the oscillator tube never really gets a chance to get hot like it does on keying the P.A. cathodes.

By removing the 'eye'-tube and the calibration crystal, there is enough room to add practically anything you'd like to build in. Buffers, multipliers, keyers, and a whole bunch more have at one time or another been put in, so have fun. This is an excellent 'imagineering' machine.

### Type 12 Transmitters

These little boxes, like the Command transmitters, are pretty neat by themselves or as the basis for projects. They run from the same supply as the Type 19 receivers and are very easy to use as is for local rag-chewers, although they are AM units.

The T-13 hits 2 meters directly however the T-11 misses by a bit. This can be easily fixed by lopping a few turns off of the tuned circuit coils and replacing the 50pf cap on the oscillator tank with a 35pf one. Note that these transmitters double in the final which can lead to extensive official correspondence that's really not pleasant. This can be avoided by careful tuning and/or a filter in the output circuit...with the preferable choice being both. The units will operate over a 2 MHz bandwidth without re-tuning which is rather convenient considering the current band arrangement.

The low voltage has to be dc and well filtered. The relays use this, but can be defeated. However the mic. circuit also uses this to get dc to the mic. (They use carbon mic's) and, unless you like hum on your audio or convert to another input circuit, this makes filtering a 'must do'.

The basic hook-up is simple-wedge a channel relay closed and plug in a crystal (6 or 8 MHz) for the proper frequency, plug in a mic., put power on the appropriate pins and you're in business.

Using these with the R-19 is equally easy. If the rear-mount power supply is being used, connect the top receptical of the receiver to the 6-pin on the transmitter pin for pin. (Pin F can be omitted.) With the outboard supply, the only difference is that pin A on the transmitter will go to the power supply +HV output and pin E will go to pin E of the upper or pin F of the lower receptical dependant on whether or not the receiver was altered as previously discussed. For frequency selection, relays can be

wedged, relays can be removed and a 5 (or more) position rotary switch installed in their place, or they can be operated as they were intended.

The T-11 unconverted and a low power HF SSB rig can become the basis for a 2 meter SSB rig with the T-11 providing the VHF input to a mixer. Likewise the T-13 (or a converted T-11) can drive a DSB power amp, for 'almost SSB'. The possibilities are endless.

While these units were designed for AM, that mode of operation is slowly disappearing (darn it). However there's nothing saying they can't be used for CW or, by modulating a varactor (or by some other method,) FM. Like the Command transmitters, these are nice basic units that leave a lot of room to play in.

### Other Units

For local rag-chewing on 220 MHz, the TV-10 (a.k.a. CV-431/AR) is a very nice basic unit. As is it works with an R-19, but won't quite hit 220 without some minor alteration.

The receiving converter has no rf stage, just a band-pass filter followed by a mixer. The local oscillator is at 110 MHz and uses the 7th overtone of the crystal. The transmitter triples in the final, which (like the Type 12's) implies careful tuning and filtering to cure any 'bad habits'. Like the Type 12's, this is a good 'project starter' unit.

Using the transmitter is just like on the Type 12 boxes- put in a crystal, plug in a mic., put power to it and let 'er rip. The 108-136 MHz receivers will work with the converter with the original 110 MHz local oscillator however the bottom couple hundred kHz will be covered up by the oscillator. One way around this is to use a 100 MHz l.o. and either frequency range receiver (the input will be the dial plus 100, which is handy) or use a different overtone of the oscillator. (I've seen one reference that says this works without any surgery and another that says it doesn't: All I can suggest is that you try...it can't hurt!)

The TV-10 and the R-19 (or other receiver) will fit the Command receiver racks nicely with only minor modification. The TV-10 and Type 12's require that the mounting angle on the front of the receiver be removed and some 'points' like on the Command and Type 15 receivers be mounted in the outboard holes from the angle mounting screws. (A couple of screws mounted so they stick out far enough that the locking 'ears' can grab them will also work.) The recepticals at the rear of the rack bays have to be removed, or rewired in the case of a Type 15 receiver. The boxes will now slide in and lock into the rack bays like they were designed to do it.

By installing a stop in one bay of a three-bay rack, a VHF transmitter (properly equipped with 'points') can be mounted in addition to the above set-up making a very nice, neat VHF/UHF installation for local work. It can be tucked into a corner

and remote controlled more or less as designed with very little effort. Aslightly rewired C-56 will do very nicely for the control side with a small panel added to handle to audio and/or key jacks.

If you have no serious objections to 50 kHz crystal-controlled channel spacings, the RT-524M is a very sweet little rig. Only needing about 6 amps of +24v power, this is a quick way to get on 2 meters AM with no bad habits. Crank the power into the switched or unswitched inputs and the amplifier input, hook-up a mic and some phones, put an antenna on it and it works.

Close examination of the antenna connectors in back will reveal that one's not tied to anything...and it mates to the other. By removing the 'dummy' and soldering a piece of coax to it gains you an instant match to an uncommon connector. (How often do you find unusual connector that come with their own mates these days?)

This rig has a really cute feature, that being that the audio amp may be run independantly from the rest of the radio. The 'RT-524' input comes from the phone output of the radio. The auxiliary inputs can come from up to four other radios, and go, with the 'RT-524' input to a resistive mixer, then to the audio amp. This is rather nice when one has a multi-radio installation and only wants one audio source to jack into...just like in an airplane.

While moving the transmitter around without a new crystal bank is tough, the receiver can feed a tuneable IF (like a Command 1.5-3 MHz receiver) since the final IF is 2 MHz. This will allow between the channel listening as well as give a BFO should CW be desireable. The transmitter may be FMed by the 'modulated varactor' or any other method you like, or may be used as the driver for a DSB power amp. Again, it is a good unit as is or as the starter for a bigger project.

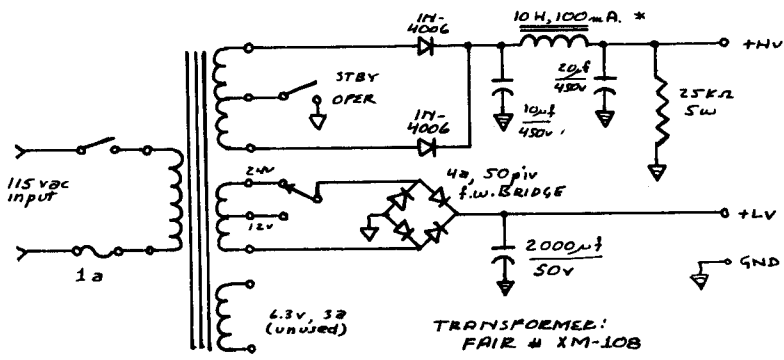

\* ALTERNATELY, USE CHOKE FROM INSIDE RECEIVER UNDER DYNAMOTOR MOUNT.

THIS P.S. MAY BE ADAPTED TO MOUNT ON A STRIPPED DYNAMOTOR MOUNT

**BASIC POWER SUPPLY**

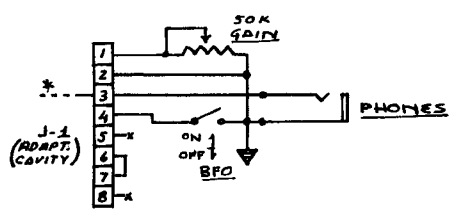

\* TO PIN 2, J-3 (ON REAR OF RECEIVER)

**COMMAND RX LOCAL CONTROL ADAPTOR  
MADE FROM  
REMOTE CONTROL ADAPTOR**

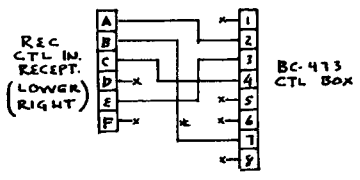

\* ONLY ON VHF REC'S. ALSO CONNECT 1K OHM RES FROM PIN 'B' OR '7' TO GND.

**TYPE 12 REC TO  
BC-473 CONNECTIONS**

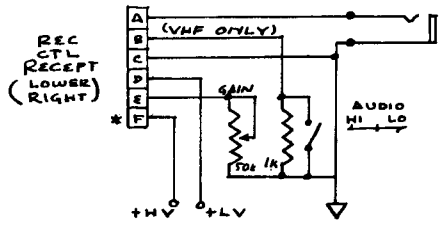

**TYPE 12  
REC CTL**

\* REMOVE WIRE FROM PIN F & MOVE WIRE FROM PIN E TO THIS PIN

R-19

VHF TRANS

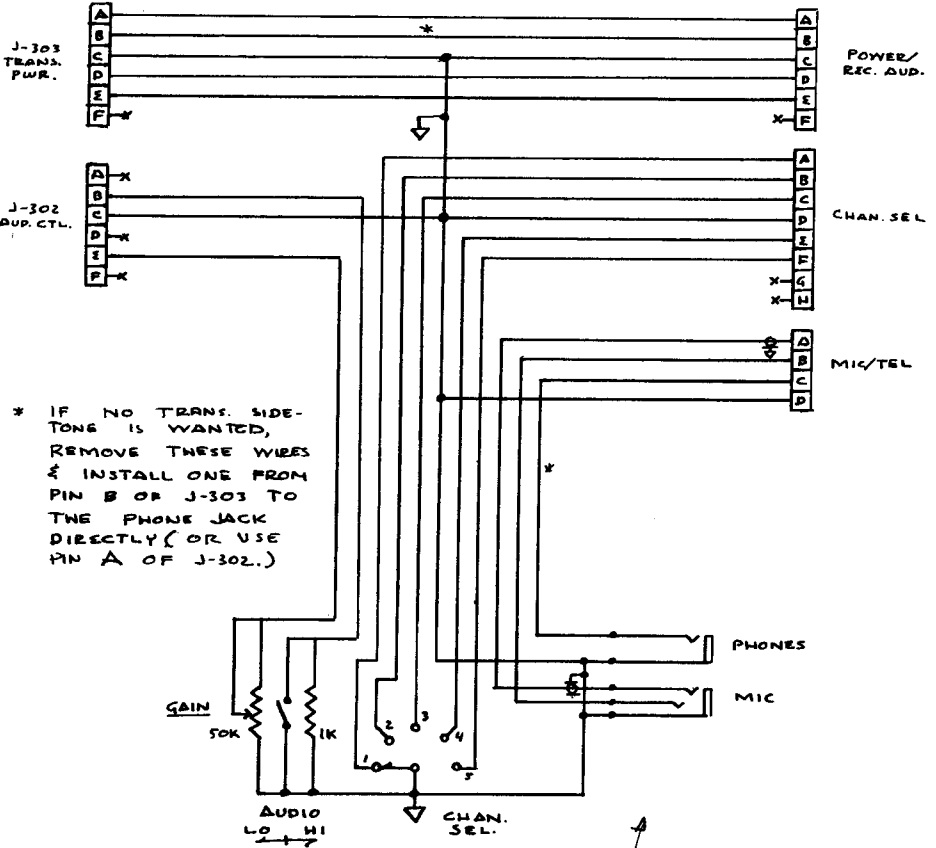

\* IF NO TRANS. SIDE-TONE IS WANTED, REMOVE THESE WIRES & INSTALL ONE FROM PIN B OF J-303 TO THE PHONE JACK DIRECTLY (OR USE PIN A OF J-302.)

CONTROL UNIT FOR R-19 & VHF TRANS

NOTE: REAR-MOUNTED P.S. IS ASSUMED.

VHF LOCAL-RAG-CHEWER

\* IF NO SIDETONE IS WANTED, REMOVE THESE WIRES & PUT IN 1 FROM J-102 PIN A OR J-303 PIN B TO THE PHONE JACK

NOTE: REAR-MOUNT POWER SUPPLY IS ASSUMED.

TV-10

VHF TRANS

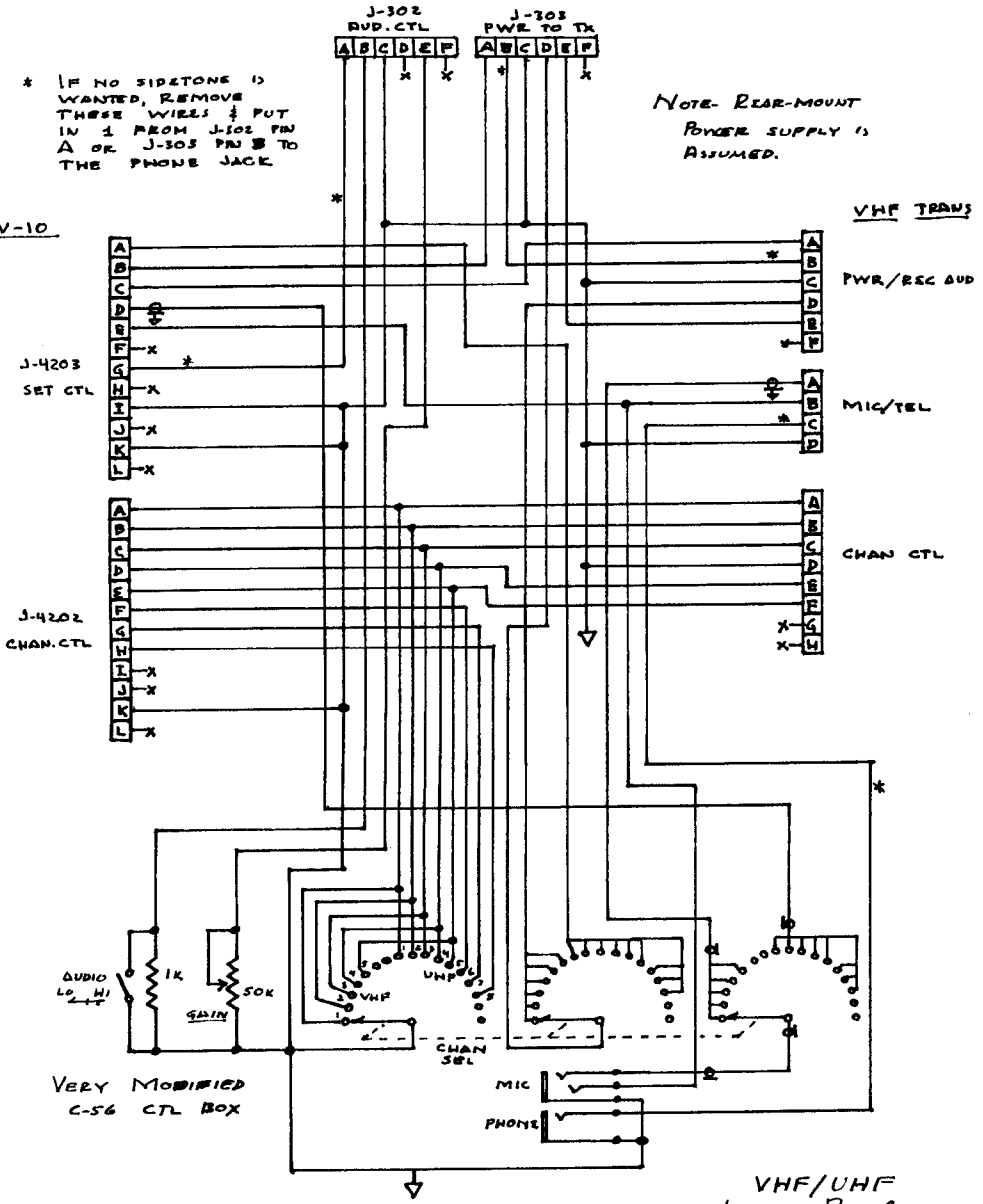

PWR/REC AUD

MIC/TEL

CHAN CTL

VERY MODIFIED C-56 CTL BOX

VHF/UHF LOCAL RAG-CHEWER



## SOME RANDOM NOTES

The foregoing has been the just the briefest outline of what can be done with these units. Detailed conversions have been avoided since they are up to the users and no two will want to do the same things or have the same 'junk boxes'. Research (another word for raiding the magazine shelf or the memory of a ham who has been in the game for a while!) will reveal a few more and probably answer any points you may have on these sets. In any event, experiment. Play with the boxes and enjoy them They Are Fun.

The voltages shown for the Command receiver B+ and the P.A. B+ for the Command transmitters are maximums. Going above them is likely to result in some rather unusual odors as components express their displeasure at the excess. The Type 12 and 15 units can go a bit higher, around 275-285 volts, but above that get very shaky. On the other hand, the Command receivers will still operate with as little as 100 volts of B+ and the transmitters will go down to about 250 volts and still work (with attendant reduction in the screen voltage, naturally!)

While everything presented has been aimed more or less at the amateur, there are other uses. The LF receivers can be used to monitor the weather reports on the aviation beacons in that range and I suspect will tune down to the 160-190 kHz band without too much bending. The VHF receivers may be used to monitor air traffic, since they are COM or NAV/COM units. If one has an RT-524A, it may still be useable in aircraft (the question being in the type certification) but as a 360 channel monitor it's very nice. The high-altitude en-route traffic can be hit the same way as discussed in the section on the RT-524M- ie, with a tuneable IF to cover the new 25 kHz channels.

Military air traffic can be monitored with a TV-10 and an R-19 if you're close to an installation. The lack of an rf stage makes for not so very good sensitivity so coverage over any appreciable distance is not too likely. Foreknowledge of the local frequencies is a must, as is patience. Military transmissions are brief and infrequent...or they're supposed to be.

The Fair type 818 transformer is being (or has been) replaced by a new and more versatile one. This is the number XM-108 transformer, which has a center tap on the 24 volt winding plus a 6 volt winding as well. This allows the 12 volt radios to be used with the same transformer by a simple power supply alteration. The new one is shown in the drawings following this section.

There are other uses for the sets. As I said before, the limiting factors are budget, junk-box, and imagination.

Enjoy.